

# Focus report: Energy Management in the Building

## Prosumer-Lab

**Author:** Andreas Hutter (CSEM)  
**Co-Authors:** Yves Stauffer (CSEM)  
 Nelson Koch (CSEM)  
 Tomasz Gorecki (CSEM)  
 Noah Plugradt (BFH-TI)  
 Cyril Topfel (BKW)

**BFE-program manager:** Dr. Michael Moser  
**BFE-project number:** SI/501434

## Abstract

The Prosumer-Lab project investigates the influence of novel strategies and components of the energy management of grid-integrated smart buildings on the stability and quality of the house and distribution grids. The project seeks to research, develop and compare fundamental knowledge, methods and products via a dedicated R&D-demonstration and test platform. The main aim is to optimize the self-consumption and to accurately assess the grid behaviour (house and distribution grid) in the interest of an optimized integration of decentralized prosumers into the distribution grid.

This document is dedicated to the presentation of the results linked to the focus area Buildings of the project. This includes the investigation on Energy Management Systems (EMS) and batteries in combination with buildings equipped with PV systems and heat pumps. The report summarizes the results of the different evaluations that been carried out to answer the research questions that have been put forward at project start. The main direction of these research questions can be summarized as follows:

- How do commercial EMS and battery systems operate and what are their performance limitations?
- What is the performance of commercial EMS, battery and EV charging systems?
- How can these systems be improved in order to achieve an optimal balance between self-consumption, energy efficiency and grid integration?

To answer these questions a laboratory test bench has been realised, which allows to evaluate the impact of different prosumer production and load situations under given and reproducible boundary conditions. These results have been complemented by simulations, where algorithms were evaluated on a yearly performance basis in co-simulation with buildings models supported by the Polysun software.

## Table of contents

1	Summary	4
2	Introduction	9
3	RQ-3034 Dynamic EMS interaction	13
4	RQ-3035 EMS comparison	17
5	RQ-3036 EMS with continuous control	20
6	RQ-3039 EMS sensitivity analysis	21
7	RQ-3040 EMS cost/benefit analysis	24
8	RQ-3007 Testing of different battery systems for the PV-Battery-System-Standardization	27
9	RQ-3011 Influence of the maximum SOC on battery round trip efficiency	30
10	RQ-3024 Emergency, Stand-Alone Operation of a Fronius Solar Battery System	33
11	RQ-3026 Solar-Log™ Control of a KEBA-Charging Station and Heat Pump in the Home Energy Environment	35
12	RQ-3033 Validation of the simulation model for PV-Battery systems	38
13	RQ-3037 EMS with battery	40
14	RQ-3038 Battery control in EMS	44
15	Conclusion	45
16	Outlook	46
17	List of Figures	47
18	List of Tables	48
19	Glossary	49
20	Definitions	50
21	Literature	50
22	Appendix	51
23	Version control	55

# 1 Summary

Prosumers are end customers who produce energy themselves in addition to normal electricity consumption. In households, this is usually done through a PV system. Electricity production and consumption seldom occur at the same time, which is why the self-consumption rate is correspondingly low. The resulting surplus electricity must then be fed into the grid, whereby the feed-in tariff in many places in Switzerland is already well below the electricity procurement costs. The increase in the self-consumption rate is therefore economically interesting for prosumers. So-called Energy Management Systems, or EMS for short, promise to increase the self-consumption rate by controlling heat pumps and batteries, where existing temporal flexibilities and thermal and electrical storage capacities are exploited. Within the Prosumer-Lab project three commercially available energy managers for typical single-family houses were evaluated together with home storage battery solution from different manufacturers in order to identify potential improvements.

This summary recalls the objectives linked to this evaluation, details the used approach and discusses the results and findings obtained for this domain within the Prosumer-Lab project.

## 1.1 Objectives

For the evaluation of the interaction between EMS, battery and EV charging systems in general as well as the performance that can be achieved with commercial systems, twelve research questions have been identified at project start. The objective of the project was to answer these research questions, which can be categorized into the following three categories:

- How do commercial EMS and battery systems operate and what are their performance limitations?
- What is the performance of commercial EMS, battery and EV charging systems?
- How can these systems be improved in order to achieve an optimal balance between self-consumption, energy efficiency and grid integration?

## 1.2 Approach

To evaluate the above research questions, two methods have been used: hardware tests on a dedicated test bench for the commercial components and software simulations to obtain yearly performance figures. The hardware test environment that was set up as part of the project allows the interaction of various hardware components of a prosumer to be tested in a realistic environment. Individual components are emulated so that different devices can be compared in a reproducible manner by the generation of generation and load profile by software. When standard weather data was used to reproduce PV production profiles, the Load Profile Generator (Pflugradt, 2019) generated realistic electric load curves and the Polysun software was used to model the entire thermal system of the building and the interaction with the heat pump. Different user and building categories are possible via parameter variations.

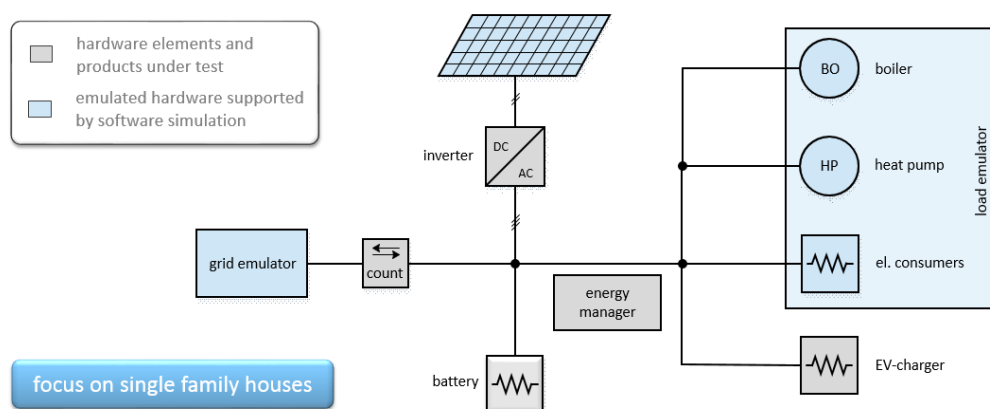

Figure 1 : The Prosumer-Lab hardware test environment.

For both, the hardware test bench and the software evaluations, two different user categories and three building types have been considered: good (Energy Performance Value of 35 kWh/m<sup>2</sup>), average (EPV of 70 kWh/m<sup>2</sup>) and poorly insulated building types (EPV of 150 kWh/m<sup>2</sup>) with either a family with two adults and two children or a working couple without kids. Air-to-water heat pumps adapted to the heat demand were used, and the PV system was dimensioned so that the PV energy produced corresponded to the annual electrical energy demand. This is referred to as the 1:1 rule, whereby a solar system with a rated output of 1 kW is installed per MWh of annual consumption. For the average annual consumption without heat pump, the Swiss mean value of approx. 5 MWh was assumed. The properties of the buildings examined resulting from these assumptions for the family with two adults and two children are summarised in Table 1.

scenario	EPV	therm. cons.	el. cons.	PV production	HP power (th./el.)	PV size
S1	35 kWh/m <sup>2</sup>	7'667 kWh	7'352 kWh	8'531 kWh	4.8/2.3 kW	7.4 kW
S3	70 kWh/m <sup>2</sup>	11'208 kWh	8'756 kWh	8'208 kWh	6.4/2.5 kW	7.2 kW
S5	150 kWh/m <sup>2</sup>	21'318 kWh	11'962 kWh	12'806 kWh	10.9/5.5 kW	11.1 kW

Table 1 : Overview of electrical and thermal characteristics of investigated building configurations.

## 1.3 Results

### 1.3.1 How do commercial MS & battery systems operate and what are performance limitations?

The three investigated commercial EMS communicate with heat pumps either via a simple digital signal that allows to switch the heat pump on or off or via the co-called SG-Ready interface, that is a two-wire digital connection that is available via an additional switching box. The two-wire SG-Ready interface, which was specified by the German Heat Pump Association (e.V., 2019), allows for four different modes: a) *normal* operation mode, b) *two hour inhibition period* mode (used to reduce consumption in peak times), c) *use-if-you-can* mode and d) *forced* mode. ) For the latter two modes the heat pump will try to increase its power consumption by exploiting thermal storage capacities, e.g. overheating of buffer tanks. The implementation of these modes is, however, not further specified and is left to choice of heat pump manufacturer. In general, implementations simply increase the buffer or storage tank temperature by e.g. 5°C for the *use-if-you-can* mode and 10°C for the *forced* mode, but this is mostly not well or inconsistently documented. Dedicated feedback if and when activation will occur is not foreseen with the SG-Ready interface. On the EMS side, simple rule-based logic based on predefined power levels and timing is used for the activation of the latter to SG-Ready modes. Continuous power control is only supported by one of the analysed EMS via a 0-100 mA analogue output. Power consumption was verified to be within the specified values from the data sheets and are in the range from 3 W to 7 W, which is resulting in an annual EMS power consumption around 40 kWh. The price for the hardware of the investigated EMS systems was around 800 CHF but does not include additional costs for required smart meters or the additional switching boxes. One EMS – the one with the continuous power control – stands out as a fully integrated solution that does not require additional equipment.

Similarly, three different home storage batteries from two brands with storage capacities ranging from 5 kWh to 48 kWh and maximum power levels from 2 kW to 24 kW were investigated. Standby power up varied largely from 16 W to maximum values observed of 65 W, corresponding to nearly 600 kWh annually.

### 1.3.2 What is the performance of EMS, battery and EV charging systems?

For the configurations from Table 1 an average of approx. 20 % to 30 % of local PV production can be consumed directly on site on an annual basis. Configurations with smaller PV systems - such as scenario S3, where PV production is lower than annual consumption - logically have higher self-consumption rates. By including a simple heat pump control by the energy manager EMS 1, the self-consumption rate can be increased on average by approx. 2 % to 4 %, see Table 2, which means that around 300 kWh more can be consumed directly on site. EMS1 supports only a simple control logic, where the heat pump is activated via SG-Ready signal as soon as PV production exceeds a predefined level. The other two commercial solutions extend this simple threshold switching with further options that allow more energy to be stored. This is achieved with EMS 2 by a hysteresis function and with EMS 3 by an additional measurement of the heat pump output. These options make it possible to further increase the internal

consumption rate by up to 1%. In general, it can be said that the systems differ only marginally in their performance, with EMS 2 being the most economically attractive solution because it does not require any additional meters or accessories. From a financial point of view, however, it is not worth it: a low feed-in tariff of 4 ct/kWh - as practised in Eggiwil in 2017 - would save just 30 to 50 CHF per year, depending on the type of building and equipment. This corresponds to an amortisation period of at least 16 years.

The situation is different with the additional use of a battery, which normally operate on their own and without EMS intervention. The self-consumption rates of a 10 kWh<sup>1</sup> battery are more than doubled here and on average 3 MWh more can be consumed directly on site. The influence of the battery capacity on the self-consumption rate is shown in the figure on the right for scenario S3. It can be seen that with capacities above 10 kWh, the increase in self-consumption quickly flattens out. In analogy to the dimensioning criterion for the PV system, the following design criterion can therefore be established: for each MWh of annual consumption, a battery capacity of maximum one kWh is installed. From a financial point of view, however, the battery does not yet really pay for itself. With the 10 kWh battery, financial savings of between 300 and 400 CHF per year can be achieved, which - with current purchase prices of at least 5'000 CHF and an expected service life of approx. 13 years (5'000 full cycles) - is just enough for amortisation over the service life.

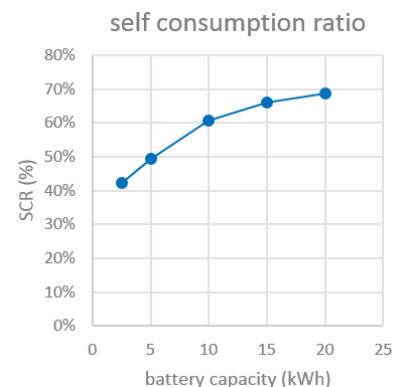

Table 2: Evolution of self-consumption rate as function of battery size, illustration for scenario S3.

scenario	reference	EMS 1	EMS 2	EMS 3	max. EMS	battery
S1	22.2 %	26.1 %	26.9 %	26.7 %	29.9 %	56.4 %
S3	29.2 %	33.1 %	33.8 %	33.5 %	38.4 %	60.6 %
S5	21.2 %	23.0 %	24.1 %	24.1 %	31.8 %	44.2 %

Table 3 : Self-consumption ratios (SCR) for reference scenario, the three investigated commercial EMS and the theoretical maximum together with SCR for system also including a battery.

As batteries are currently not economically beneficial for end users, their usage in the context of emergency and stand-alone operation was investigated using the Fronius solar battery system. The tested systems work as expected, but it must be emphasised that it takes almost one minute to restore the electric power (after grid failure), a hierarchy between the loads is to be done and that only small loads shall be targeted as otherwise the battery is emptied too fast.

As cars have relatively large batteries, they could be perfect candidates to increase SCR at a reasonable cost, as the battery comes with the car and not as an additional item. In that context, an EMS connected to a KEBA-charging station was tested. The three charging modes of the EMS were tested, namely full charge (i.e. charge at maximal rate as soon as possible), solar charge (charge only with the PV) and mixed charge. As expected, doing so could greatly increase SCR, if the car is available and plugged in during PV production.

### 1.3.3 How can these systems be improved?

By assuming that the heat pump can always be operated when PVs are producing energy, then the theoretical maximum energy that can be consumed directly on site can be determined. On a yearly basis this optimization potential was evaluated to be in the order of 3 to 8 % w.r.t. current EMS, which equals to at least doubling the performance of current systems (see also Table 2). This potential can be exploited especially at the beginning and end of the heating period - when the heat pump runs less than 50 % of the day. Theoretically, for scenario S3, instead of the 300 kWh, with optimum heat control up to 1300 kWh - i.e. at least four times more - could be consumed directly on site.

There are various ways of exploiting this potential. For example, the size of the buffer storages can be increased. The simulations showed that with tanks 2 times larger the annual self-consumption rate can be further increased by 2 % - 500 kWh instead of 300 kWh are now consumed directly on site. It is worth

<sup>1</sup> The same battery size as the one used for the evaluation on the hardware emulation platform was used for yearly evaluation (done by simulation and based on standard model from Polysun library).

pointing out that less than 20% of this SCR increase is lost in thermal losses at tank level. When compared to the total heat generated by the heat pump, the tank losses represent 5% in the case of the large tank and 3% in the original tank configuration. Note that, the tank losses increase (10kWh elec.) linked to using EMS1 instead of the reference controller, with the original tank size in both cases, is small with respect to the SCR increase (300kWh). A similar effect can be achieved by increasing the tank temperatures. Heat pumps are usually limited to approx. 60°C and a further increase can be achieved with heating rods. Another method is to continuously adjust the output power of the heat pump to the excess PV power. It has been shown that this solution is almost as efficient as the larger buffer tanks, with an increase in self-consumption rate of approx. 1.5%, but without any additional installation costs. Modern frequency-controlled heat pumps support this power adjustment in principle but cannot be exploited with the SG-Ready interface available today. Further optimisation potential can then be exploited via model-based algorithms that predict the development of thermal consumption and PV production, which have been shown to approach the theoretical performance limits. Such solutions are also very suitable for the effective use of the thermal storage potential of larger buildings, where excess energy can also be stored in the building directly. Thermal storage capacities are much higher for such cases, e.g. about 60 kWh of thermal energy can be stored in a 300m<sup>2</sup> concrete ceiling by overheating up to 2°C whereas only 6 kWh can be stored when overheating a 500 l buffer tank by 10°C. It is however difficult to exploit such theoretical capacity values in practice because of large time constants above 10 hours and as it requires individual room control. But the biggest hurdle to size the available improvement potential is the lack of standardization efforts of the heat pump industry in order to facilitate optimum heat pump activation and control in combination with local PV production.

On the battery side, simple control systems such as those integrated today directly in the home storage solutions are quite sufficient to increasing self-consumption. Finally, in order to make batteries more attractive, a charging strategy that does not fully charge the battery was investigated. The last 10-20% of charge are suboptimal for the lifetime, based on cell tests. It was shown that this also applies to battery systems. But in the system test the energy loss per discharged kWh went down the more fully the battery was utilized. This shows that using oversized batteries and then only partially charging them seems not to be an optimal strategy from an efficiency standpoint.

Many different factors influence the system performance of a PV-Battery-system, such as charging efficiency, discharging efficiency, response time, maximum and minimum power, standby power, the weather, the load profile and much more. To accurately compare two systems, the impact for an entire year in a real system needs to be evaluated. But due to practicality and cost reasons carrying out year-long tests on the test bench is not feasible. To work around the problem, a detailed battery model was developed together with other partners in order to facilitate detailed analysis. It was shown that on average the error between this model and the real battery is ~16%. The model is documented in detail in "Effizienzleitfaden für PV-Speichersysteme 2.0" of the HTW Berlin (Berlin, 2019).

## 1.4 Discussion

From a purely economic point of view, the use of energy managers to increase the rate of private consumption is not sensible for single-family houses. Existing improvement potentials can be achieved by the correct planning and dimensioning of the system components or the implementation of efficient algorithms for heat pump control. The latter option, although economically more interesting as it requires lower investment costs in hardware, can today not easily be sized due to the absence of uniform ways to activate and efficiently control heat pumps, e.g. the current SG-Ready interface is not suitable to allow for the continuous adaptation of the heat-pump power to the available surplus PV power. The standardization of such interfaces would greatly contribute to exploit the available optimization potential (see also Recommendations below). Today, the integration of batteries makes sense from a technical point of view, but not from an economic point of view. Simple control systems for battery storage systems such as those integrated today directly in the home storage solution have been identified to be quite sufficient to increase self-consumption. However, they are not suitable for grid stability, see investigations done in the Focus Distribution Grid Integration.

Whenever the focus of this study was on single family houses, the results and conclusions also apply qualitatively for larger buildings, such as multi-apartment as well as commercial and office buildings or self-consumption communities (ZEV). The fundamental differences lie in the fact that bigger thermal storage

capacities can be exploited – which however increases system complexity, as direct interaction with the building management system is required – and that the economic viability can be achieved much more quickly. Future development effort and support should therefore be put in this domain. In the frame of the Prosumer-Lab hardware infrastructure, the evaluation of units with power levels up to 50 kVA is possible, which is sufficient for single family houses and small self-consumption communities, e.g. multi-home buildings with up to nine apartments<sup>2</sup>. For bigger entities or industrial sites, creating or extending current evaluation platforms to higher power levels in the range of up to 200 kVA should be considered.

The soft- and hardware test bench is maintained at BFH Energy Storage Research Centre and available for interested parties to evaluate and validate their product improvements.

### 1.5 Recommendations

Within the project it was shown that the current SG-Ready interface is not efficient to exploit the available optimization potential with respect to the control of the heat pump and associated thermal storage assets. For the investigated single family houses it was shown via four day lasting hardware evaluations as well as yearly simulations that only 50% of the available optimization potential for increasing self-consumption and autarky can be exploited at best. It is therefore recommended to extend the SG-Ready interface or to define a new standard, that allows to access the available potential in a uniform and cost-efficient manner, e.g. similar to the way the SunSpec Alliance standardized the data interface to access and control PV inverters. The minimum requirement for such a standard is the possibility to adapt the heat pump power continuously and the provision of an information of the current storage status of the system, e.g. via tank temperatures. Additional features, like for instance the possibility to directly control the required inflow temperature of the heating circuit, would be beneficial, especially for bigger buildings.

**Important note:** when referring to SCR or SCE increase, unless otherwise specified, the increase is to be understood as **absolute**. Accordingly, a SCR of 20% increased by 3% results in a SCR of 23%. This convention was chosen to prevent the extensive use of formulations such as “an absolute increase with the unit of percent”.

<sup>2</sup> In Switzerland the working practice from VSE for multi-apartment buildings with 4 and up to 9 apartments foresees overcurrent level of 63 A, which corresponds to a connection power of ~44 kW. [18]



## 2 Introduction

The objective of the focus area buildings was to investigate the ability of commercially available energy management systems (EMS) to interact efficiently with thermal and electrical storage devices to improve the use of locally produced PV energy, e.g. to increase the self-consumption. The focus was put on single-family houses and the evaluation of commercially available hardware components, where three energy management systems, one home storage battery solutions, one EV charger as well as one PV inverter were investigated. This corresponds to the topics highlighted in orange in Figure 2; this figure also provides the relationship with other Prosumer-Lab topics that are highlighted in blue.

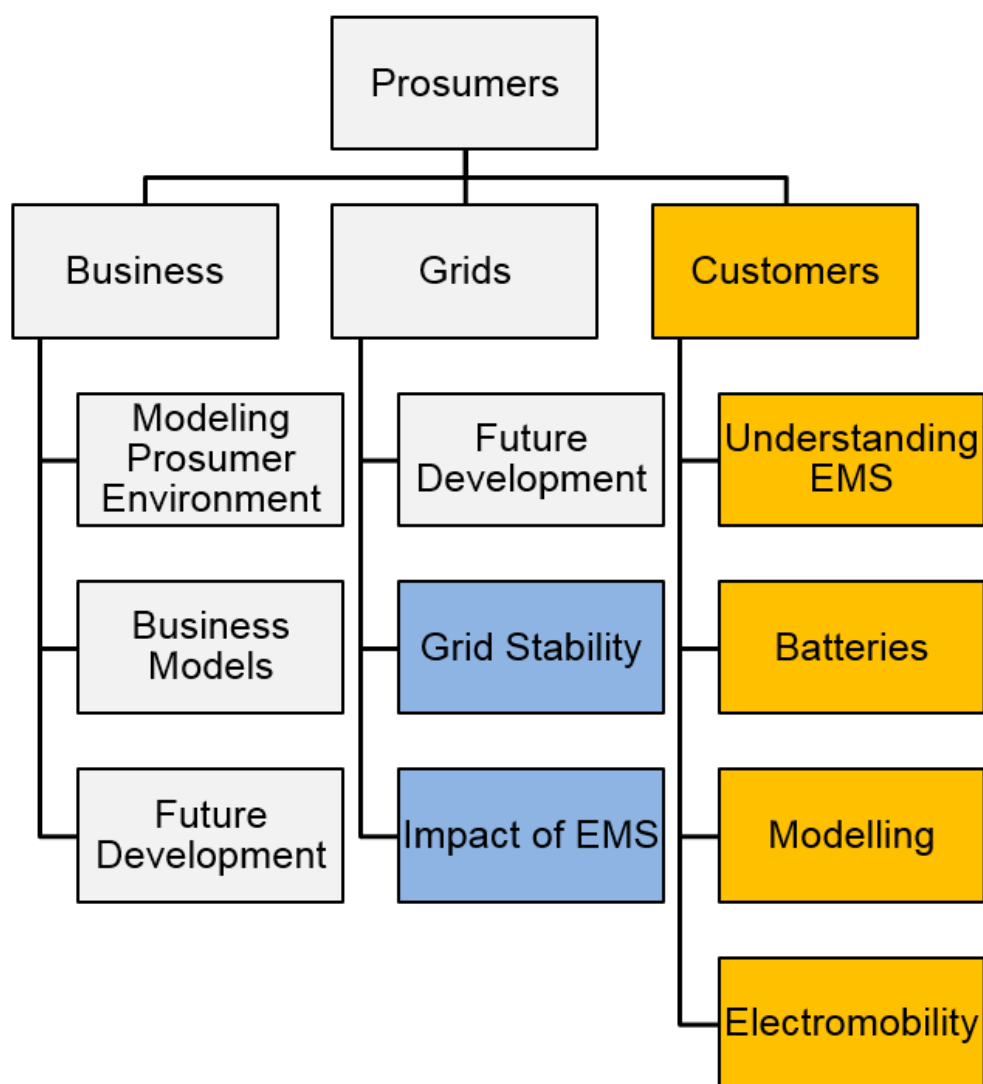

Figure 2 : Prosumer-Lab research fields. The ones linked to this report are highlighted in orange. Research fields that provide relevant input are highlighted in blue.

### 2.1 Investigated Products

#### 2.1.1 Energy Managers

Three commercial EMS from SmartFox, SolarLog and SolarWatt have been investigated. All three EMS use the 4-wire SmartGrid-Ready Interface to interact with a heat pump. All systems support electrochemical storage solutions: EMS1 only supports the solution provided directly by the

manufacturer of the EMS whereas the other two systems support a variety different battery solutions. Based on our investigation battery support is limited to reading state-of-charge information but no active control of charging set-points is issued by the investigated energy managers. Furthermore, energy managers differ by the need for additional sensed inputs (electric power exchange between the prosumer and the grid) and finally mainly by the price for the complete solutions, as two systems require also add-on components. The main characteristics of the investigated EMS are provided in the following table.

Table 4 : Overview of the main characteristics of the evaluated Energy Management Systems.

characteristic	EMS1	EMS2	EMS3
Heat pump control	SG-Ready <sup>3</sup>	SG-Ready <sup>3</sup>	SG-Ready, 0-100%
Generic battery control	no	no	no
Required external counters	2	2	0
price	CHF 880.- <sup>4</sup>	CHF 835.- <sup>4</sup>	CHF 833.-

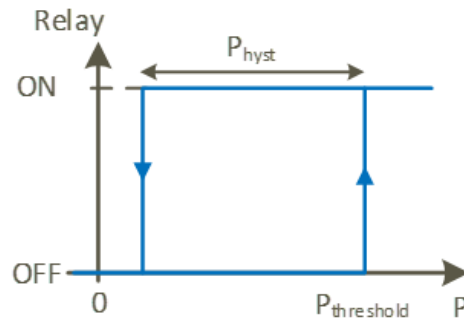

Figure 3 : illustration of the EMS switching strategy

The SG-Ready support is operated by all energy managers via simple power switching decision as illustrated in Figure 3. Where two EMS use the measured power at the grid injection point  $P_{grid}$  as decision variable, EMS2 also deduces the power consumption of the heat pump and used  $P_{grid} - P_{HP}$  for its decision. EMS2 and EMS3 also support a hysteresis for switching the heat pump on and off. All EMS provide two timing delays that allows for a smooth operation. As such,  $T_{min}^{ON}$  is the minimum time that the heat pump control signal will be maintained in ON state, thus even if the switching condition is no longer true.  $T_{min}^{OFF}$  is the same for turning the heat pump control signal off again, which assures a minimum off time between heat pump activations. An overview of the EMS configuration parameters that have been used throughout the entire investigation are shown in Table 5.

Table 5 : Overview of main configuration parameters of the evaluated Energy Management Systems.

characteristic	EMS1	EMS2	EMS3
$P_{threshold}$	$P_{max}^{HP}$	$P_{max}^{HP}$	$P_{max}^{HP}$
$P_{hyst}$	0 <sup>5</sup>	$P_{max}^{HP}$	$P_{max}^{HP}$
$T_{min}^{ON}$	20 minutes	20 minutes	20 minutes
$T_{min}^{OFF}$	2 minutes	2 minutes	2 minutes

### 2.1.2 Home Storage Solutions

For this project, the system element 6 of the manufacturer Varta was used to observe the influence of a home energy storage on the Prosumer's energetic performance. The principal characteristics of this device are resumed in Table 6

<sup>3</sup> Requires additional component to provide 2-wire SG-Ready signal

<sup>4</sup> Price for additional components for provision of SG-Ready signal and counters not included

<sup>5</sup> No hysteresis is supported by EMS1

Table 6 : Varta element 6 characteristics.

Characteristic	Varta element 6 <sup>6</sup>
Nominal ( <i>useful</i> ) capacity	6.4 kWh (5.8 kWh)
(Dis)charge power	2 kW
Grid connection	400 VAC, 50 Hz, 3 phases
Technology	Lithium-Ion
Dimension WxHxD	600x1176x500 mm
Weight	145 kg

The Varta element 6 includes an internal inverter which converts the DC energy of the battery to an AC current and vice versa. With this system, the battery can directly be connected to the principal distribution point of the building.

This battery operates automatically. An integrated energy management system (EMS) has the goal to reduce the amount of energy exchanged with the grid. To achieve this objective, a power meter, which is provided by Varta, must be installed on the grid connection of the prosumer. In this way, the productions surplus can easily be detected, and the EMS can try to decrease the injection by charging the battery. In the same idea, the energy storage system will be discharged if a lack of power is measured at the house introduction point.

The Varta device cannot be controlled externally. The Ethernet connection can only be used to consult the battery's status via a web interface. This channel is also used by some EMS to read the energy storage's information like the SOC or the (dis)charging power.

For testing on the Prosumer-Lab testbench, the Varta element 6 was connected in parallel to the PV inverter output and the load emulator to reproduce a principal distribution point like in a real configuration. The power meter was installed directly on the grid emulator output to measure the energy drawn from and fed to the grid.

### 2.1.3 EV chargers

The KEBA KeContact P30 charging station, c-series, was used for the tests focusing on how an EMS can handle multiple controllable loads (charging station plus heat pump).

The KEBA KeContact P30 wallbox is available in four different equipment series, which are compatible with all electric vehicles and plug-in hybrids, covering use cases and markets worldwide. For the particular applications considered in these tests, the c-series version of the charging station was used. The c-series offers a charging capacity of up to 22 kW for faster charging and features MID-certified, intelligent charging and smart home integration.

The KeContact P30 offers various application possibilities thanks to the state-of-the-art communication standards, which are implemented. The wallbox charging station is easily controlled and status information can be accessed via User Data Protocol (UDP) in a smart home.

For example, the maximum permissible amount of electrical charge for an EV can be regulated, based on a PV system, battery storage unit or heat pump. The latter configuration was considered in the tests discussed in this report. In addition, external meter data can be read out, using the Modbus TC Protocol. This means that the charging station is capable of regulating the EV charging processes, e.g. charging depending on house connection.

The features of the KEBA KeConnect P30 c-series charging station are summarized in Table 7.

<sup>6</sup> Manufacturer's announced information

Table 7: Main features of KEBA KeContact P30 charging station.

<b>KEBA KeConnect P30 c-series charging station</b>
Three phase charging, up to 32 A (22 kW)
Charge Mode 3, in accordance with IEC 61851-1 AC charging
Power and Current Monitoring available
Rated supply voltage (Europe): 3 x 230 V / 400 V
USB interface and Ethernet interface for permanent installation (LSA+)
UDP interface for smart home automation

## 2.2 Evaluation procedures

Within the project a test environment was created that allows to evaluate the interaction of these hardware components in a realistic environment [2]. The other components of a typical prosumer system are then emulated so that different hardware devices can be compared in a reproducible manner (Figure 6). The energy from the PV system is generated via PV emulators, where the use of weather data files for a reference period assures that the system will then generate the same power profile for each and every evaluated configuration. The same applies for the heat pump but in a slightly more complicated way. The entire thermal system of the household is modelled in the Prosumer-Lab using Polysun software [3], which allows the thermal demand for domestic hot water (DHW) and heating energy to be determined by means of user behaviour and weather data specifications. The heat pump, which can be selected from an extensive Polysun library of commercially available models, is now emulated within Polysun in such a way that the interaction with the existing buffer tanks for domestic hot water and the space heating (SH) system covers the necessary heat demand. To produce the associated power to flow through the emulation platform, the electricity consumption of the heat pump calculated by Polysun is then mapped together with the electricity consumption of the electrical consumers, which are created with the Load Profile Generator [4] on the basis of user characteristics, onto a load emulator. The latter assures that real currents flows on the consumption side, whereas the grid emulator ensures the appropriate power flowing either from or to the grid as imposed by the configuration. With this design the switching behaviour and the interaction between energy manager, heat pump and other storage devices can be investigated in run time. Detailed emulation results are documented in [5].

In addition to the laboratory tests, simulations were also carried out in order to obtain information on the performance of the systems on a yearly basis. Good (EPV<sup>7</sup> of 35 kWh/m<sup>2</sup>), average (70 kWh/m<sup>2</sup>) and poorly insulated building types (150 kWh/m<sup>2</sup>) were investigated, whereby the user behaviour of either a family with two adults and two children (scenarios S1, S3 and S5) or a working couple without kids (S2, S4 and S6) was assumed. Air-to-water heat pumps adapted to the heat demand were used together with two buffer tanks: a 300 l tank for space heating and 200 l for domestic hot water. In case of SG-Ready control, overheating of the standard buffer tank temperature set-points of up to 10°C was allowed for SH and 5°C for DHW. The PV system was dimensioned such that the PV energy produced corresponded to the annual electrical energy demand, the so-called 1:1 rule: for 1MWh annual consumption a solar plant with a nominal output of 1kW is installed. For the average annual consumption without heat pump, the Swiss mean value of approx. 5 MWh was assumed to calibrate the Load Profile Generator. The evaluation horizon is set to one year and the year 2015 was used as reference year. The meteorological data from Koppigen in the canton of Bern was used. The properties of the buildings examined resulting from these assumptions are summarised in Table 8. The configuration of scenario S3 corresponds to the settings that were also used for the hardware emulator described above. Detailed simulation results are documented in [6] and also published in [7].

<sup>7</sup> EPV refers to the Energy Performance Value, which is the yearly average thermal consumption per usable area.

Table 8 : Overview on thermal and electric characteristics of the reference buildings used in the simulation studies.

Scenario	EPV <sup>7</sup>	thermal consumption <sup>8</sup>	total electrical consumption <sup>9</sup>	PV production	HP power (electrical/thermal)	PV size
S1	35 kWh/m <sup>2</sup>	7'667 kWh	7'352 kWh	8'531 kWh	4.8/2.3 <sup>10</sup> kW	7.4 kW
S2	35 kWh/m <sup>2</sup>	7'180 kWh	5'771 kWh	6'762 kWh	4.8/2.3 <sup>10</sup> kW	5.5 kW
S3	70 kWh/m <sup>2</sup>	10'429 kWh	8'450 kWh	9'839 kWh	6.4/2.5 <sup>11</sup> kW	7.2 <sup>12</sup> kW
S4	70 kWh/m <sup>2</sup>	9'354 kWh	6'654 kWh	7'592 kWh	6.4/2.5 <sup>11</sup> kW	6.6 kW
S5	150 kWh/m <sup>2</sup>	21'318 kWh	11'962 kWh	14'119 kWh	10.9/5.5 <sup>13</sup> kW	11.1 kW
S6	150 kWh/m <sup>2</sup>	21'145 kWh	10'437 kWh	12'924 kWh	10.9/5.5 <sup>13</sup> kW	10.6 kW

### 3 RQ-3034 Dynamic EMS interaction

#### *What is the dynamic behaviour of the three commercial EMS?*

This research question addresses assessment of the EMS dynamic, especially identifying response times, accuracy of the commutation thresholds and reproducibility of the results. The purpose being to experimentally validate the dynamic behaviour in comparison to the one announced by the manufacturer. Moreover, the power consumption of the EMS is measured and presented as well. These two aspects will be presented separately below.

#### 3.1 Method

##### 3.1.1 Consumption

In order to measure the energy consumption of the evaluated EMS, the setup presented in Figure 4 has been implemented. This figure represents the topology of the supply sources for each EMS as well as the location of the power meter.

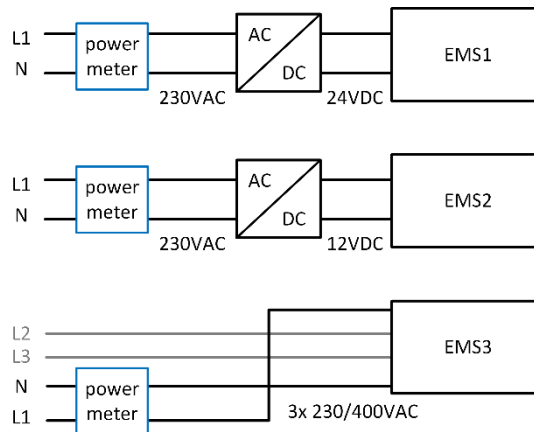

Figure 4 : Power supply topology and location of power measurement for the three EMS.

EMS1 and EMS2 are both supplied through a DC power supply, respectively in 24 Vdc and 12 Vdc. As for EMS3, it is supplied through phase 1 of its 3-phase voltage measurement. The power meters are

<sup>8</sup> Thermal energy usage of the building (i.e. without pipe losses).

<sup>9</sup> Sum of space heating, domestic hot water and appliance consumption.

<sup>10</sup> Belaria SRM 4

<sup>11</sup> Belaria SRM 6

<sup>12</sup> Note that this PV is not sized according to the 1:1 rule, this choice was made to allow further comparisons between obtained results on the test bench.

<sup>13</sup> Belaria SRM 14

placed upstream from the power supply, when present, so that the total consumption (EMS + power supply) is taken into account.

The measurements are performed using a “smart-me Plug” from smart-me AG (Figure 5). This device allows online data logging at 1-second temporal resolution and an accuracy of 1% (class 1) over a range of 0.1-3680W. The measurements were carried out during 24 hours of normal operation.



Figure 5 : Power meter “smart-me Plug” from smart-me AG used for the measurement of the EMS power consumption.

### 3.1.2 Dynamic behaviour

The dynamic behaviour of the EMS is evaluated by means of specifically developed 2-hour load and PV profiles. These profiles are depicted in Figure 6. They consist of a constant load consumption of 1 kW and a varying photovoltaic production.

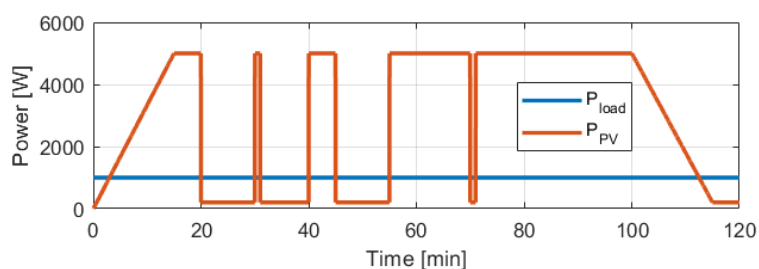

Figure 6 : 2-hours load and PV profiles for the dynamic assessment of the EMS.

The PV production profile starts with a 15-minute ramp of increasing power up to 5 kW. It is then followed by a series of low (200 W) and high (5 kW) power production of duration varying from 1 to 30 minutes. Finally, the production profile ends up with a decreasing ramp. The purpose of this slightly complicated profile is to be able to evaluate every single switching conditions and associated timing. In order to evaluate the reproducibility of the control, this evaluation profile has been repeated 2 to 8 times for each EMS.

The emulation framework used for this evaluation is similar to the one presented earlier in Figure 9, each EMS being tested one after the other. However, the EMS configuration parameters have been adapted as presented in Table 9. Moreover, in this framework the control signal of the EMS is used to directly control an emulated 3 kW load. In other words, when the control signal of the EMS is activated, an additional 3 kW is added on top of the constant 1 kW load consumption.

Table 9 : Main configuration parameters of the evaluated Energy Managers used in the dynamic behaviour assessment.

characteristic	EMS1	EMS2	EMS3
$P_{threshold}$	3 kW	3 kW	3 kW
$P_{hyst}$	0	3 kW	3 kW
$T_{min}^{ON}$	3 minutes	3 minutes	3 minutes
$T_{min}^{OFF}$	2 minutes	2 minutes	2 minutes

## 3.2 Results

### 3.2.1 Consumption

Figure 7 presents the daily power consumption measured for each EMS.

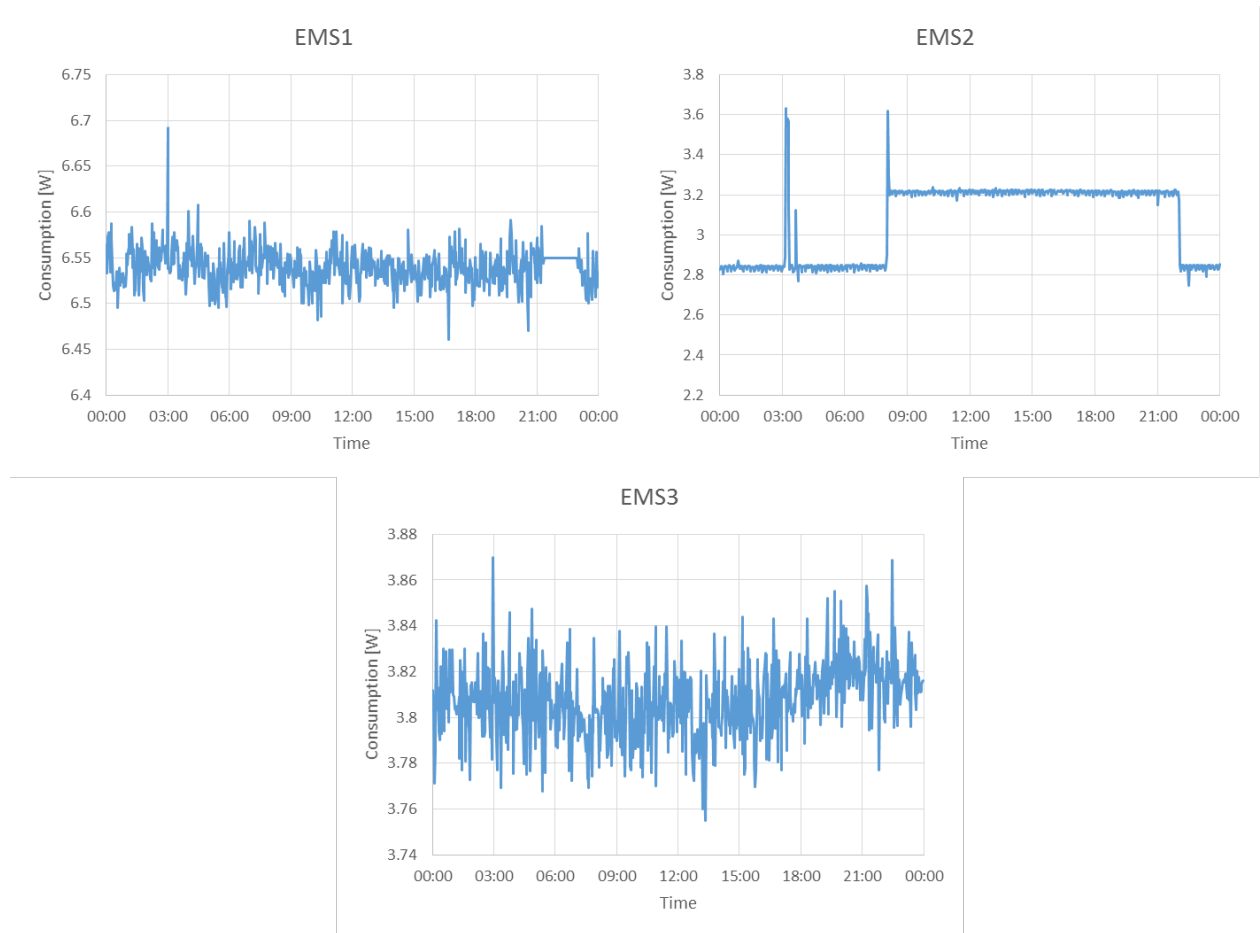

Figure 7 : Daily energy consumption measured for each EMS.

These results are summarized and compared to the power consumption announced by the manufacturer in Table 10. In general, the power consumption is well aligned with the one announced, except for EMS1. Although the announced value is for the main device only, without accounting for power supply efficiency (84 %) and the “digital extension” consumption (1.4 W), the measured power consumption is almost twice higher. In Table 10 depicts the extrapolated yearly energy consumption, based on the measurement and assuming the daily consumption being constant over the year.

Table 10 : Announced and daily averaged measured power consumption for each EMS as well as the extrapolated yearly energy consumption.

	EMS1	EMS2	EMS3
Announced power consumption [W]	2.4 <sup>14</sup>	3.0	3.0-4.0
Averaged measured power consumption [W]	6.6	3.1	3.8
Extrapolated yearly energy consumption [kWh]	57.8	27.2	33.3

<sup>14</sup> The announced power consumption doesn't include the power supply and the additional digital extension.

### 3.2.2 Dynamic behaviour

For the sake of conciseness, the results of only one of the set of tests applied to each EMS is depicted in Figure 8. In the upper graph, in blue the grid exchanged power measured is shown (positive when injected into the grid) and in dashed red the 3 kW threshold configured in the EMS. In the lower graph the state of the control signal of the EMS is depicted as well as the duration [min:sec] during which the control signal was in that state.

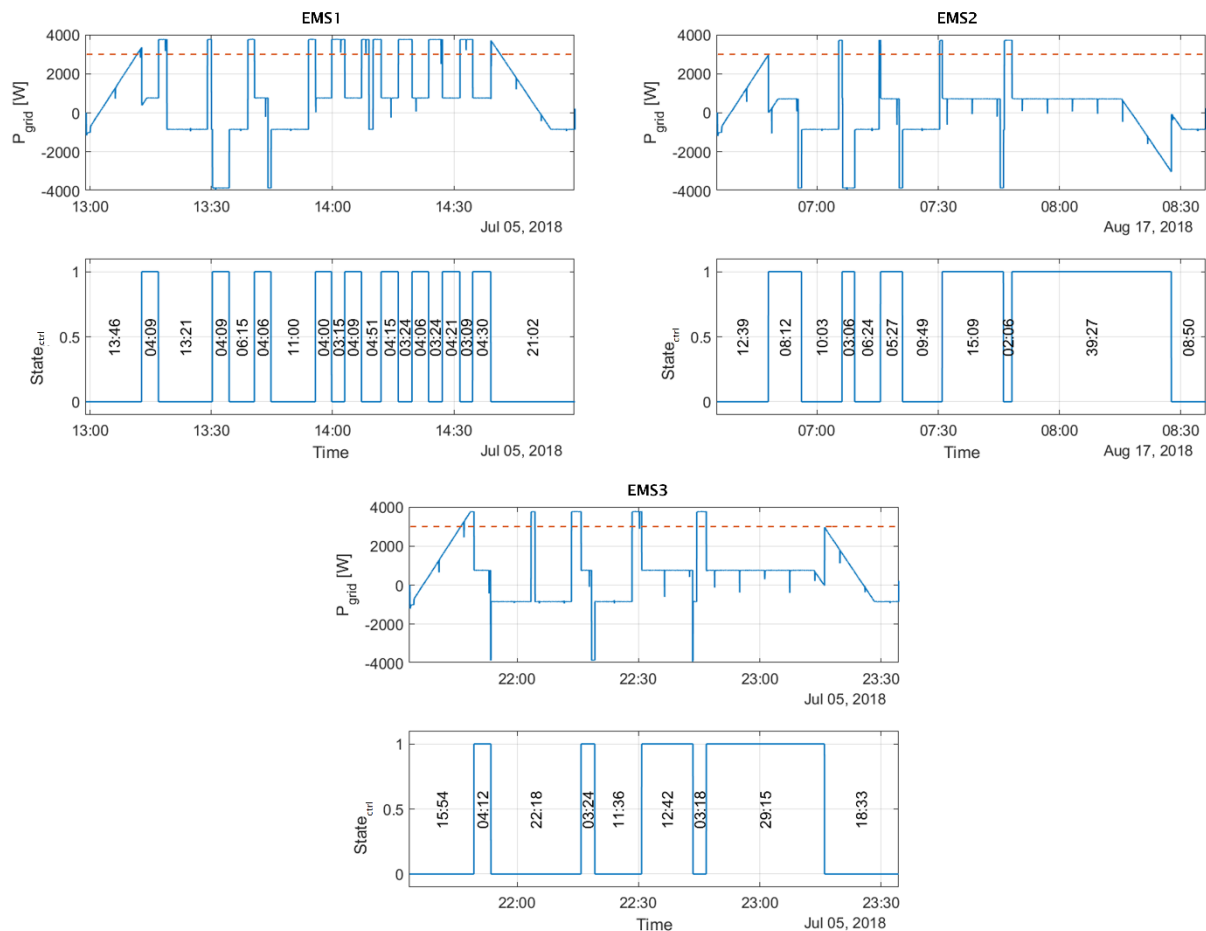

Figure 8 : Results of a single dynamic test for each EMS.

Note that the results are different from one EMS to the next since the control strategy implemented in each device is slightly different.

According to these results and based on the observation of the other tests, the EMS are evaluated on the three following points: accuracy of commutation thresholds, accuracy of timing and reproducibility. These evaluations are gathered in Table 11.



Table 11 : Evaluation of the EMS dynamic behavior based on the set of dynamic tests performed.

	EMS1	EMS2	EMS3
<b>Threshold</b>	✓ Slightly higher than expected with 1-2 min delay or power offset ~400 W	✓ As expected with ~18 sec delay or power offset ~140 W	✓ As expected with ~7 sec delay
<b>Timing</b>	✓ Higher than expected with +73±12 sec offset	✓ As expected with +6±0 sec offset	✓ As expected with +22±2 sec offset
<b>Reproducibility</b>	✓ Some inconsistency certainly due to the uncertainty in timing and measurement	✓ Almost perfectly consistent, one inconsistent test result probably due to measurement issues	✓ Perfectly reproducible, results higher similar for all the tests performed

### 3.3 Summary

Focusing first on the EMS dynamic assessment, we can conclude that they behave in general as specified by the manufacturers. Only minor divergences have been observed regarding the accuracy of the measurements and timings which can be defined as acceptable for such an application. However, beyond these accuracy discrepancies, some random behaviours have also been observed with EMS1 and EMS2. These observations tend to suggest that these EMS may have trouble with bad measurement data (since they appear sporadically). These corrupted measurements may lead to bad control decision which may then affect the overall operating cost.

When it comes to the energy consumption of the EMS and putting them into perspective to their cost/benefit analysis presented below in RQ-3040, we can conclude that the cost related to the energy consumption of these devices is non-negligible. Indeed, based on the electricity tariffs used in the RQ-3040, the operating cost for the best-case scenario (lowest EMS energy consumption and lowest energy tariff) is CHF 4.20 and goes up to CHF 12.70 for the worst case scenario (highest EMS electricity consumption and higher electricity tariff). This will have as a result a reduction of the economic benefits of these solutions. Knowing that these benefits are already low (or even non-existent), the use of such devices for the reduction of operating cost is therefore questionable.

## 4 RQ-3035 EMS comparison

*What is the performance of the three selected commercial EMS for standard operation, e.g. house with PV, heat-pump, no electric boiler and no battery?*

This research question addresses the issue of determination of self-consumption and degree-of-autarky based on evaluation of a standard year in simulation. The reference case (i.e. without EMS) will be compared to the considered EMSs.; comparison to case without EMS

### 4.1 Method

In order to answer this research question, yearly simulations were carried out in Polysun using the three EMS mentioned above in addition to the standard Polysun EMS.

The simulation layout (i.e. building, HP, etc.) corresponds to the elements listed in Table 8. An illustration of the simulation layout for the case S1 is provided in Figure 9.

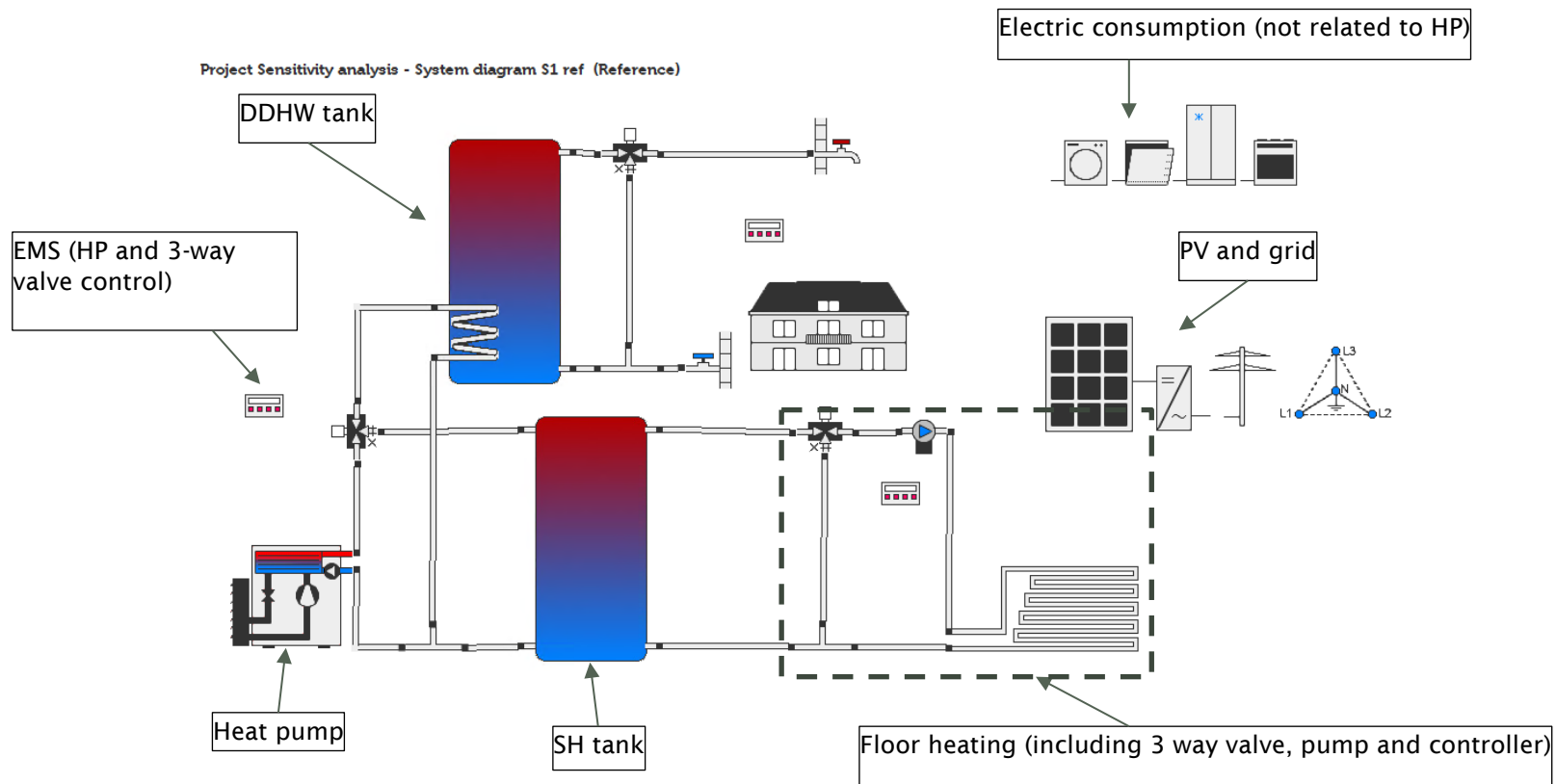

Figure 9 : Polysun simulation layout for case S1 .

## 4.2 Results

The results in terms of SCR and autarky are provided in the tables below:

- SCR Table 12 (in %) and SCE Table 13 (in kWh), for the 3 EMSs and the one of the reference controller are presented. On the same tables, the SCR and SCE increase w.r.t reference controller is also provided.
- Table 14 represents the autarky (in %) as well as the autarky increase with regard to the reference for the 3 EMSs.

Table 12 : SCR in % for the 3 EMS and absolute SCR increase w.r.t. reference case (in parenthesis).

	SCR and SCR increase w.r.t ref (in parenthesis) in %				
	ref	EMS3	EMS1	EMS2	Average
<b>S1</b>	22	27 (5)	26 (4)	27 (4)	<b>(4)</b>
<b>S2</b>	22	27 (5)	26 (4)	26 (5)	<b>(5)</b>
<b>S3</b>	22	25 (4)	25 (3)	25 (4)	<b>(3)</b>
<b>S4</b>	21	24 (4)	25 (4)	24 (4)	<b>(4)</b>
<b>S5</b>	21	23 (3)	22 (2)	23 (3)	<b>(2)</b>
<b>S6</b>	18	21 (3)	20 (2)	21 (3)	<b>(2)</b>
<b>Average</b>	21	<b>(4)</b>	<b>(3)</b>	<b>(4)</b>	

Table 13 : SCE in kWh for the 3 EMS and absolute SCE increase w.r.t. reference case (in parenthesis).

	SCE and SCE increase w.r.t ref (in parenthesis) in kWh				
	ref	EMS3	EMS1	EMS2	average
<b>S1</b>	1'903	2294 (391)	2231 (328)	2275 (372)	2'176
<b>S2</b>	1'460	1803 (343)	1762 (302)	1777 (317)	1'701
<b>S3</b>	2'140	2495 (355)	2415 (275)	2508 (368)	2'390
<b>S4</b>	1'565	1859 (294)	1868 (303)	1848 (283)	1'785
<b>S5</b>	2'928	3301 (373)	3148 (220)	3291 (363)	3'167
<b>S6</b>	2'359	2691 (332)	2645 (286)	2698 (339)	2'598
<b>Average</b>	2059	<b>(348)</b>	<b>(286)</b>	<b>(340)</b>	

Table 14 : autarky in % for the 3 EMS and absolute autarky increase w.r.t. reference case (in parenthesis).

	autarky and autarky increase w.r.t ref (in parenthesis) in %				
	ref	EMS3	EMS1	EMS2	Average
<b>S1</b>	26	31 (5)	30 (4)	31 (5)	<b>(5)</b>
<b>S2</b>	25	31 (6)	30 (5)	30 (5)	<b>(5)</b>
<b>S3</b>	25	29 (4)	28 (3)	29 (4)	<b>(4)</b>
<b>S4</b>	23	28 (4)	28 (4)	27 (4)	<b>(4)</b>
<b>S5</b>	24	27 (3)	26 (2)	27 (3)	<b>(3)</b>
<b>S6</b>	23	26 (3)	25 (3)	26 (3)	<b>(3)</b>
<b>Average</b>		<b>(4)</b>	<b>(4)</b>	<b>(4)</b>	

### 4.3 Summary

For SCR and autarky, the following observations can be made.

First, all EMS provide an improvement of ~4%. This is illustrated by the last line labelled as *average* in Table 12 and Table 14. Given the similarity in the control logic associated to the choice of similar parameters for the switching conditions, such a result was to be expected.

Second, the relative increases are higher for the cases S1/2 (good insulation), followed by S3/S4 (medium insulation) and finally S5/S6 (bad insulation). %. This is illustrated by the last column labelled as *average* in Table 12 and Table 14. The hypothesis is that two effects are combined:

- 1) Badly insulated houses consume more, thus even the standard heat pump controller (i.e. reference) is good at self-consuming (see SCE Table 13). In consequence the 3 EMS can't improve a lot the SCR for these cases.
- 2) The additional SCR (in %) is penalized by the huge PV production increase between case S1/2 and S5/6. There is an absolute increase of SCR (in kWh, Table 13). However, the PV production increase is a lot larger (Table 8), than the decrease in SCR (in %).

## 5 RQ-3036 EMS with continuous control

*What is the impact of continuous control or discrete control compared to simple on/off control?*

This research question addresses the issue of the determination of self-consumption and autarky based on evaluation of standard year when continuous HP control is applied and compare the results to the on/off control from RQ-3035

### 5.1 Method

The same simulation environment as in section 4.1 is employed. The main difference is that the HP can now be controlled in continuous mode. In that case, the HP can be turned on at a minimal power (in this case ~1/2 of the nominal power) and be continuously controlled (in electric power) until the nominal (electric) power value. The control logic for the modulated HP controller was chosen to be the one of the EMS1 with a turn-on threshold set half as high as the maximum HP power. In other words, the HP turns on at half of its maximal power and continuously adapts its consumption based on the grid injection. The power can be increased until the maximal HP power is reached.

### 5.2 Results

SCR and SCR increase are provided in Table 15 whereas autarky and autarky increase are given in Table 16.

Note that the results of the reference controller and EMS1 are the same as in Section 4. They are provided here in order to facilitate the comparison with the modulated version of the EMS.

Table 15 : SCR in % for the reference, EMS1 and Modulated EMS and absolute SCR increase w.r.t. reference case (in parenthesis).

	SCR and SCR increase w.r.t ref (in parenthesis) in %		
	ref	EMS1	Modulated
<b>S1</b>	22	26 (4)	28 (6)
<b>S2</b>	22	26 (4)	28 (6)
<b>S3</b>	22	25 (3)	26 (4)
<b>S4</b>	21	25 (4)	26 (5)
<b>S5</b>	21	22 (2)	24 (3)
<b>S6</b>	18	20 (2)	22 (4)
<b>Average</b>		<b>(3)</b>	<b>(5)</b>

Table 16 : autarky in % for the reference, EMS1 and Modulated EMS and absolute autarky increase w.r.t. reference case (in parenthesis).

	autarky and autarky increase w.r.t ref (in parenthesis) in %		
	ref	EMS1	Modulated
<b>S1</b>	26	30 (4)	32 (6)
<b>S2</b>	25	30 (5)	33 (7)
<b>S3</b>	25	28 (3)	30 (5)
<b>S4</b>	23	28 (4)	29 (6)
<b>S5</b>	24	26 (2)	28 (4)
<b>S6</b>	23	25 (3)	27 (4)
<b>Average</b>		<b>(4)</b>	<b>(5)</b>

### 5.3 Summary

Similar results in terms of SCR and autarky as in Section 4.3 can be drawn. Namely, the modulation increases SCR by 2 % (difference between the *average* value of the EMS1 and modulated EMS in Table 15) and autarky by an additional 1 % (difference between the *average* value of the EMS1 and modulated EMS in Table 16) and the modulation works better (in terms of SCR and autarky) for well insulated houses. Nevertheless, this small SCR increase is a low hanging fruit in terms of algorithmic implementation. It needs however the HP to be able to: 1) support modulation 2) accept modulation commands from the EMS.

## 6 RQ-3039 EMS sensitivity analysis

*What is the impact of adding EMS features for different configurations, e.g. user number and dimensioning of tanks?*

This research question addresses the issue of determination of self-consumption and degree-of-autarky based on evaluation of a standard year by comparing different PV peak powers and different tank (SH and DHW) sizes.

### 6.1 Method

The same simulation environment as in Section 4 was used. All simulations were carried on the S1 case using EMS1. The PV and tank sizes were changed as highlighted in Table 17 and Table 18.

Table 17 : Tested PV peak powers.

Peak power	3.7 kWp	14.8 kWp	37.1 kWp
Ratio w.r.t. 1:1 rule	0.5	2	5

Table 18 : Tested tank sizes.

Tank sizes	150 l DHW / 100 l SH	600 l DHW / 400 l SH	300 l DHW / 2000 l SH
Ratio w.r.t reference case	0.5	2	10

## 6.2 Results

The results for the PV size variation are provided in Figure 10 (SCR and autarky), and Figure 11 (total electricity consumption). As expected, SCR decreases as the PV size is increased whereas the autarky increases.

The results for the tank sizes variation are provided in Figure 12 (SCR),

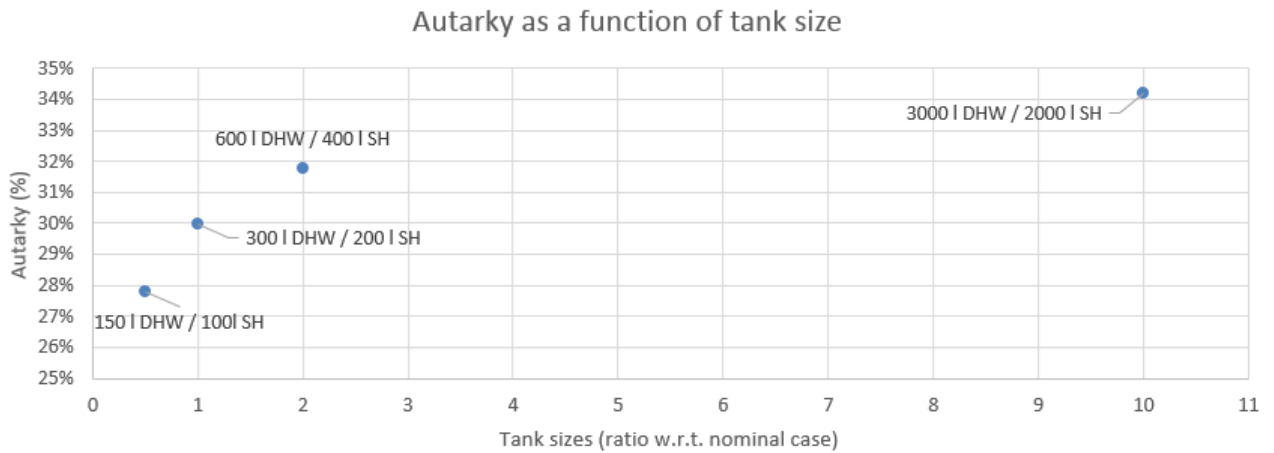

Figure 13 (autarky) and Figure 14) total electricity consumption). As expected, both the SCR and autarky are increased by using bigger tanks.

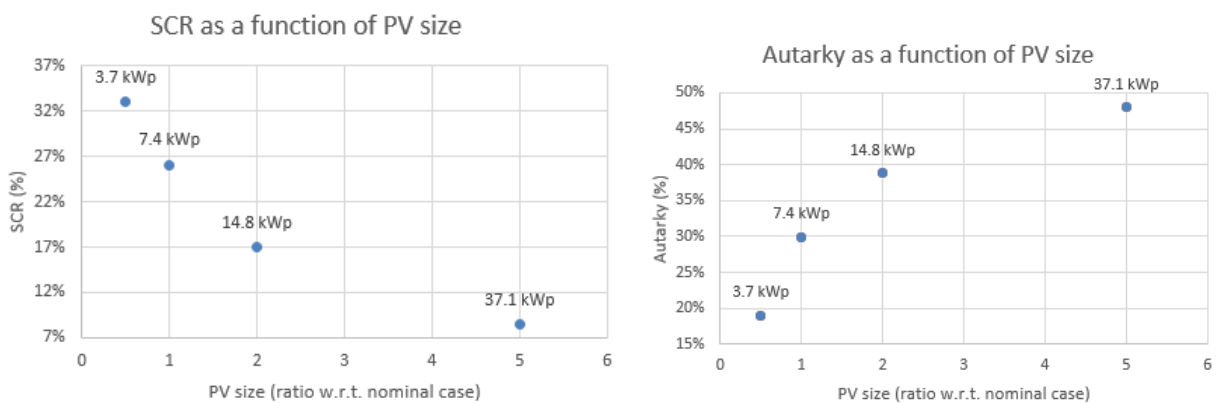

Figure 10 : SCR as a function of PV size (left), autarky as a function of PV size (right)

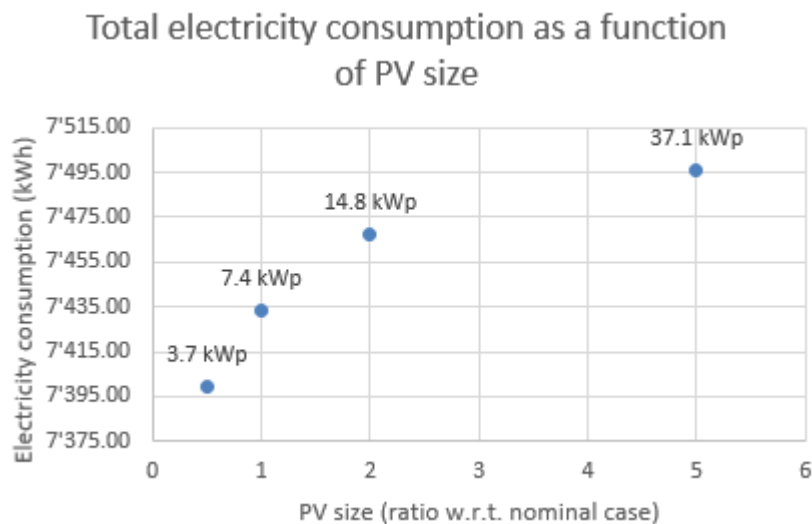

Figure 11 : electricity consumption as a function of PV size

SCR as a function of tank size

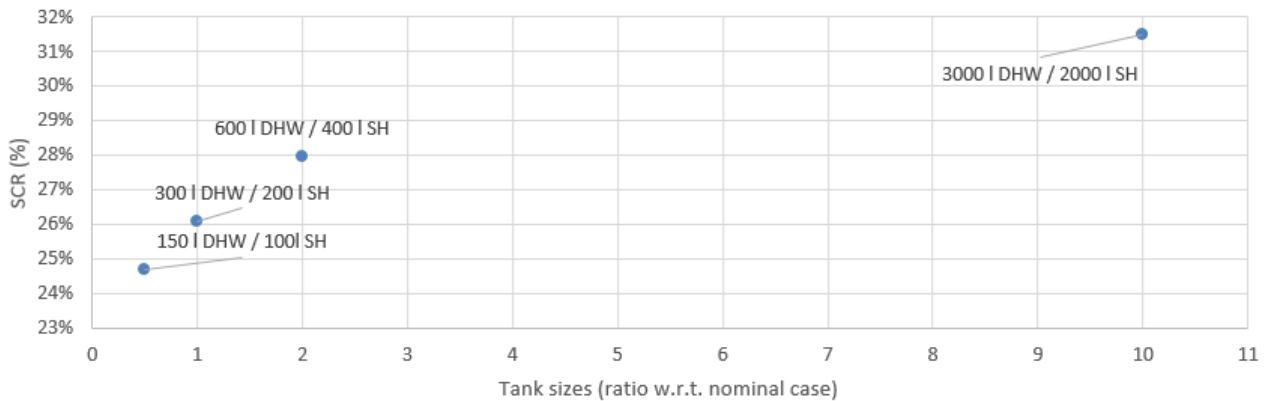

Figure 12 : SCR as a function of tank sizes

Autarky as a function of tank size

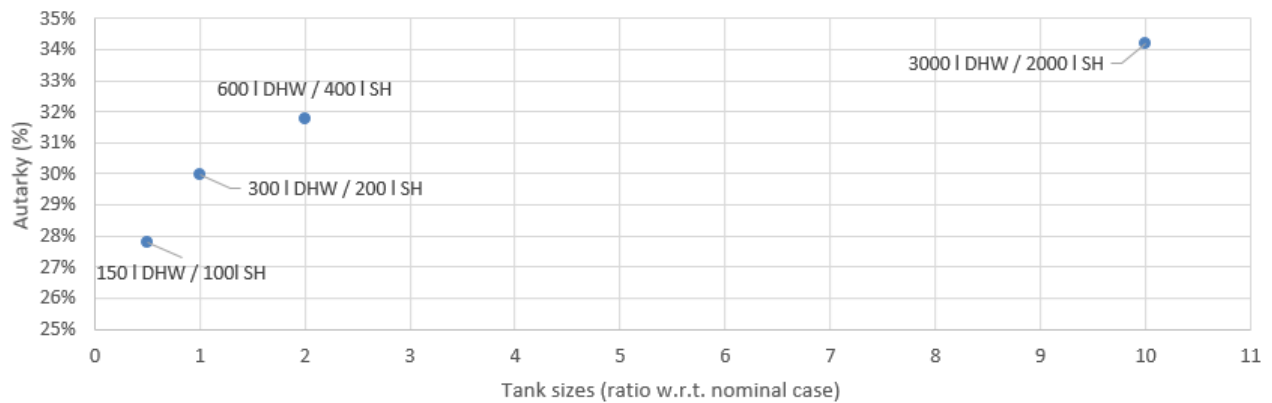

Figure 13 : autarky as a function of tank sizes

Total electricity consumption as a function of tank size

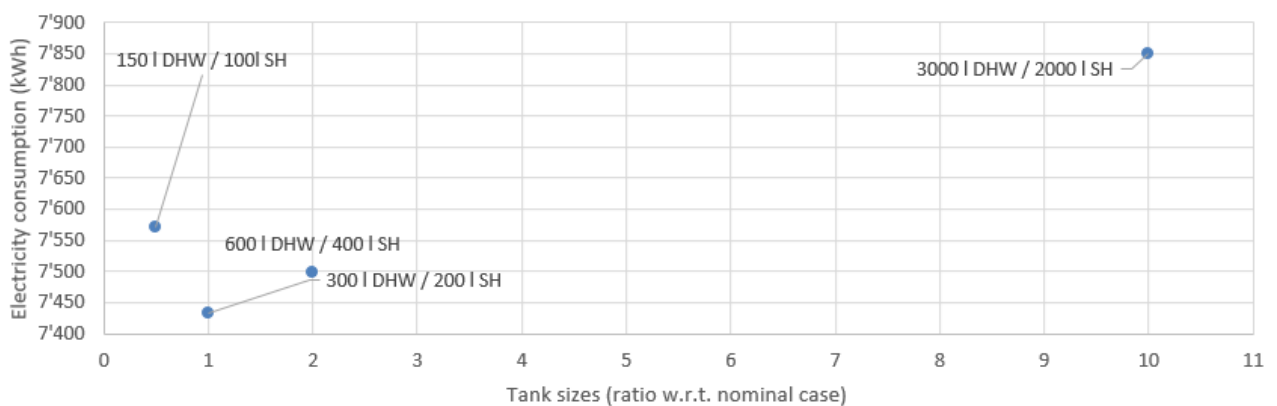

Figure 14 : total electricity consumption as a function of tank sizes

### 6.3 Summary

For the PV size increase, the SCR decreases whereas the autarky increases. This indicates that the absolute self-consumption (in kWh) increase is smaller than the additional PV production, hence the SCR decrease (in %). On the other hand, there is still an absolute (in kWh) self-consumption increase, thus the autarky increases (in %). In addition, a moderate increase of the total electricity consumption can be observed (Figure 11). This is linked to a more frequent activation of the overheating, that leads

to a (on average) higher tank temperature (and higher HP working temperature) thus more losses. Also, in the event of quickly fluctuating irradiance, an overheating event might be triggered, that forces the HP to run a specific minimal amount of time. This even if the irradiance drops. Such events are more frequent as the PV system size increases. In consequence, a financial analysis is to be carried out to better refine the optimal PV sizing.

For the tank size increases, both SCR and autarky increase. On the other hand, the total electricity consumption is also impacted by the sizing. The general trend seems to indicate an electric consumption increase as a function of tank increase (i.e. more losses, which is to be expected). However, for the original tank sizing (i.e. 300 l for DHW and 200 l for SH) the electricity consumption is the lowest. This effect is most likely not linked to tank insulation properties as only the volume is changed between the simulations. As for the PV sizing, a financial analysis is to be done to find the optimal tanks sizing trade off.

## 7 RQ-3040 EMS cost/benefit analysis

*What is the impact of PV (and battery size) on the overall associated cost benefits incl. investment costs and operational gains?*

This research question addresses the issue of determination of the financial impact (operational (OPEX) and capital (CAPEX)):

- On S1 to S6 (from Sections 4 & 5)
- Linked to the PV sizing and tank sizing (from Section 6)

### 7.1 Method

The same simulations as listed in Sections 4, 5 and 6 are used. Two main quantities are extracted related to electric energy exchange with the grid, namely injected and extracted energy. To assess the OPEX (**linked to energy transactions only**) three different electricity tariffs were used. These are summarized in Table 19.

Table 19: used electricity tariffs

	<b>Koppigen</b>	<b>Bern</b>	<b>Eggiwil</b>
	<b>Tariff 1</b>	<b>Tariff 2</b>	<b>Tariff 3</b>
<b>To grid (Chf/kWh)</b>	0.155	0.1009	0.04
<b>From grid (Chf/kWh)</b>	0.155	0.1869	0.2197

### 7.2 Results

For the cases presented in Sections 4 & 5 (i.e. not related to the sensitivity analysis), the results are summarized below. In order to facilitate the analysis, only the yearly cost difference with regards to the standard controller is provided in:

- Table 20: for the tariff 1
- Table 32: for the tariff 2
- Table 21: for the tariff 3

These tables already indicate a clear impact of the electricity tariffs, which was expected. They also highlight that in case of grid parity (i.e. selling equal to buying tariff) increasing SCR is not desirable. This can be observed in a clearer way in Figure 15 that provides the total yearly cost for all the solutions presented in Sections 3, 5 (i.e. not related to the sensitivity analysis).



Table 20 : yearly cost difference w.r.t ref controller with tariff 1 (smaller values indicate cheaper solutions, negative values indicate benefits for the prosumer)

	Yearly cost difference w.r.t. ref. with Tariff 1 (Koppigen) (CHF)			
	EMS3	EMS1	EMS2	Modulated
S1	13	13	14	14
S2	10	5	10	7
S3	11	11	11	5
S4	10	7	10	4
S5	14	11	14	7
S6	10	5	10	5

Table 21 : yearly cost difference w.r.t ref controller with tariff 3 (smaller values indicate cheaper solutions, negative values indicate benefits for the prosumer)

	Yearly cost difference w.r.t. ref. with Tariff 3 (Eggiwil) (CHF)			
	EMS3	EMS1	EMS2	Modulated
S1	-51	-40	-46	-65
S2	-48	-47	-43	-69
S3	-48	-33	-50	-71
S4	-39	-45	-37	-64
S5	-47	-25	-45	-72
S6	-45	-44	-46	-76

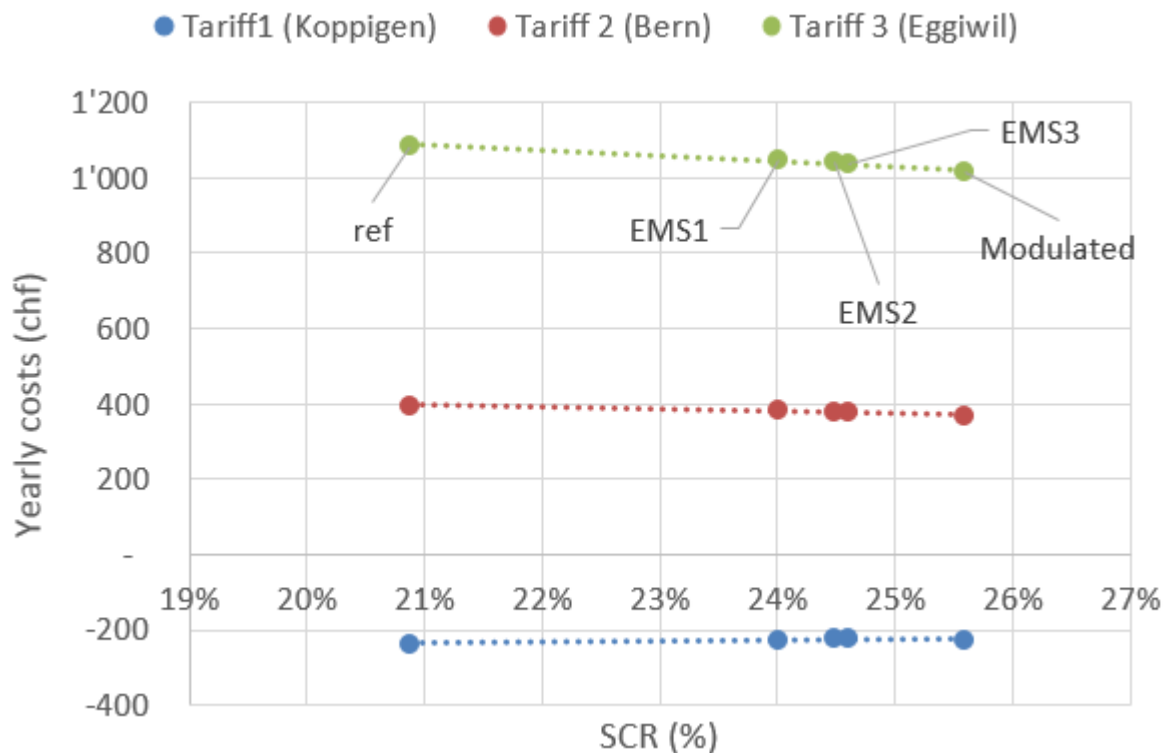

Figure 15 : yearly cost for the three tariffs (including all EMS and) as a function of SCR (smaller costs indicate cheaper solutions, negative values indicate benefits for the prosumer)

For the PV size variation, the same simulation layout and size variation as described in Section 6 were used. For the computation, the tariffs of Table 19 are employed. Figure 16, provides the yearly electricity costs for the different tariffs and different sizes of PV installations the financial details in terms of difference w.r.t. the nominal PV sizing is provided in Table 33 (in the Appendix). As expected, more PV is reducing the yearly costs, and allows even to earn money. Naturally, more money can be made in case of favorable energy tariffs (i.e. high reward for PV production, as it is the case for Tariff 1). This can be observed by the slope of Figure 16.

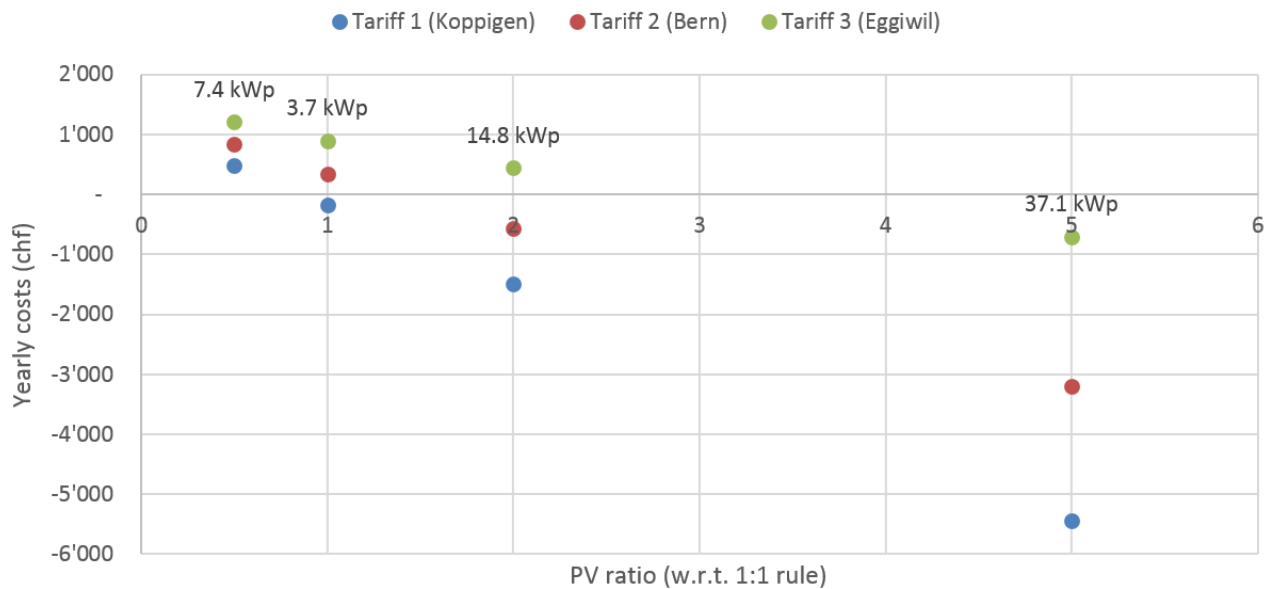

Figure 16 : yearly electricity cost for S1 using different PV sizes (w.r.t. nominal sizing) (smaller costs indicate cheaper solutions, negative values indicate benefits for the prosumer)

For the tank size variation, the results are provided in Figure 17 (yearly electricity cost for different tariffs and tank sizes) and Table 34 (in the appendix). It can be observed that the impact of tanks size has less impact on the total cost and that (on average) the lowest cost is obtained for the original tank size.

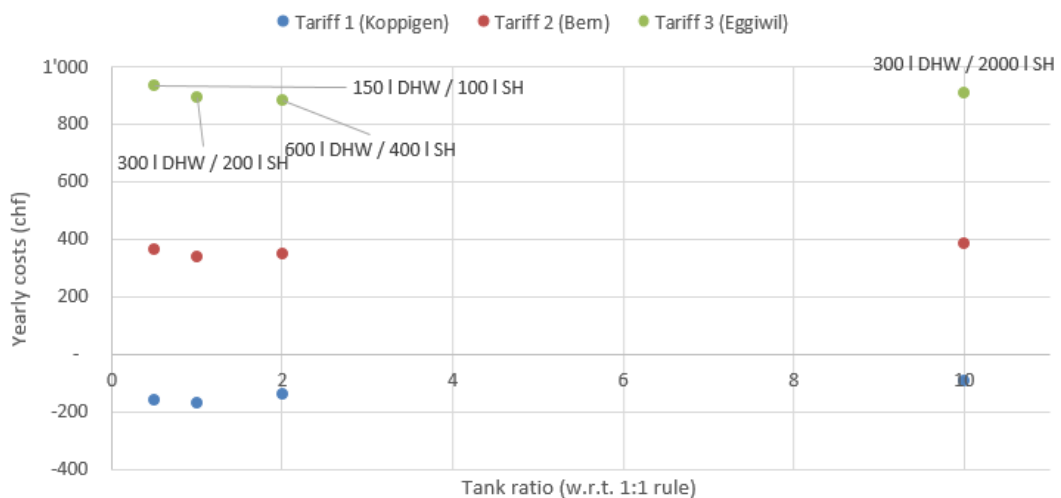

Figure 17 : yearly electricity cost for S1 using different tank sizes (w.r.t. nominal sizing) (negative values indicate more gains for the user)

### 7.3 Summary

For the OPEX linked to energy exchanges with the grid. The following observations can be made when the different EMS, including modulation, are compared.

First, depending on the tariff, SCR increase is not desirable as it might increase to total yearly costs, this can be observed on Figure 15 for tariff 1. In that case, since there is grid parity, the electric grid can be viewed as a “free perfect battery”, any form of local storage will include losses that would not occur with the grid and are thus to be prevented. In case of less favourable injection tariffs, increasing SCR is desirable.

Second, in the case of favourable tariffs (Table 21), the average savings provided by the 3 EMS over all the possible scenarios of ~43 CHF per year. Meaning that a payback time of around 20 years is to be expected just to cover the EMS HW costs (~800 CHF / device, Table 4). Installing such devices, is currently not interesting from a financial point of view.

Third, the same condition of favourable tariffs (Table 21), heat pump modulation brings average savings (over all the scenarios) of ~69 CHF per year (i.e. increases the savings of 23 CHF w.r.t. the average EMS costs).

For OPEX linked to PV sizing and taking into account costs linked to grid exchanges only, it can be observed that adding more PV is desirable in any case, the effect is naturally higher if the injection tariff is more favourable (Figure 16). It must be emphasised again that capital expenses linked to PV are not taken into account in this analysis.

When investing the impact of tank sizing, with the same restrictions as for PV sizing, the results are summarized in Figure 17 where two observations can be made. First, for tariff 1, increasing the tank size leads to higher cost. Which is expected as with grid parity storage is not advisable (the same holds if a battery is installed). Second, for tariffs 2 and 3, the behaviour is less clear. One would expect bigger savings with a bigger tank, in particular for tariff 3. But for some reason, an optimum seems to be located around the nominal sizing and the ratio 2 (i.e. tank twice the size). It is very possible that the factor 10 leads to considerably more heat dissipation thus the benefits from storing are lost.

**Given the EMS costs given in Table 4, that do not even take into account the installation costs, such savings are not interesting (too long payback, etc.)**

## 8 RQ-3007 Testing of different battery systems for the PV-Battery-System-Standardization

How to best compare batteries in PV-Battery systems?

### 8.1 Summary

PV-Battery systems are difficult to compare. They have different efficiencies for charging and discharging, further depending on the current power, they have a standby consumption and a self-discharge rate. It is therefore very difficult to determine if a given system will perform better than another system. To reduce consumer frustration which might endanger the rapid adoption of this technology, which is essential for the energy system transition, a project was started in Germany to develop a standardised measuring process for the comparison of different systems. The consortium defined four characteristic parameters - path efficiency, standby consumption, energy efficiency and settling time. The PVLab participated in this standardisation process and performed a number of different measurements for the validation of the model.

## 8.2 Method

For this research question tests with different battery systems were performed. The battery systems are shown in Table 22.

Table 22: Tested battery systems.

Name	Power [kW]	Energy [kWh]
Varta element 6	2	6.4
sonnen Pro 48	24	48
sonnen Eco 4.5	2.5	4.5

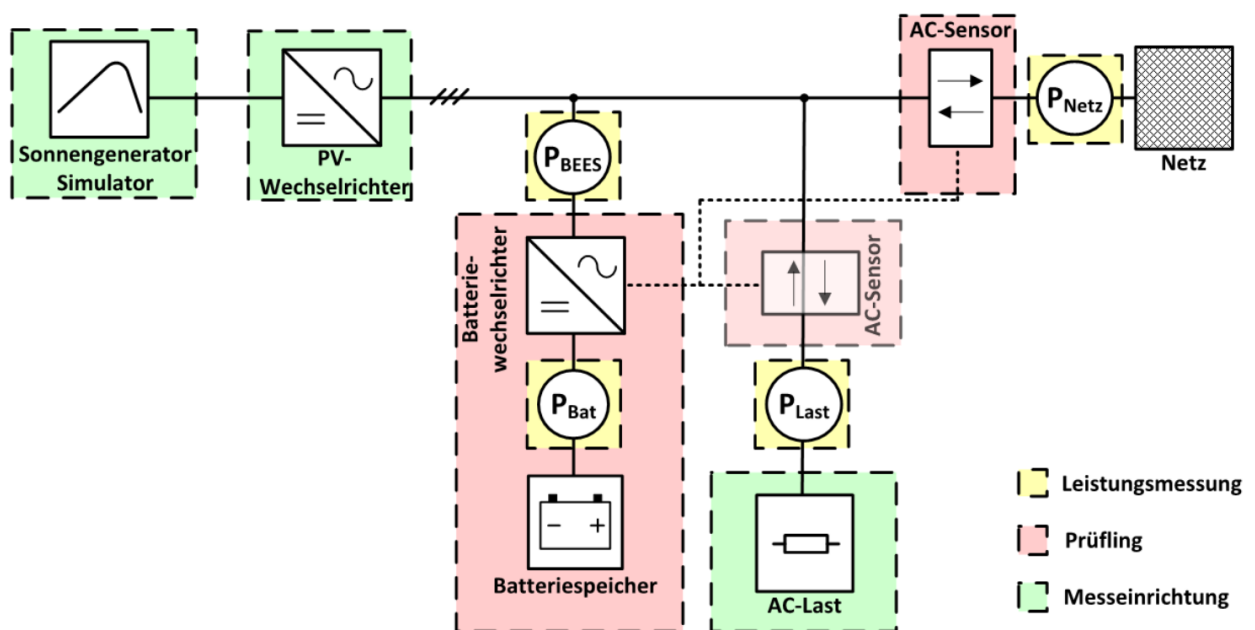

Figure 18: Schema of the battery system.

The schema for hooking up an AC Battery system is shown in Figure 18. To accurately monitor the AC energy flows in the system, three measurement points are needed, which are labelled  $P_{BEES}$ ,  $P_{Last}$  and  $P_{Netz}$ .

Each of the battery systems was connected to the simulator and then measurements were performed in different scenarios. The results of this are shown in the next section.

## 8.3 Results

The results of the measurements at different power levels, normalized to the maximum power of the unit are shown in Figure 19 and Figure 20. It is visible that the Varta element 6's performance is well below the performance of the other two systems and that especially when the power is rather low, the efficiency is very bad.

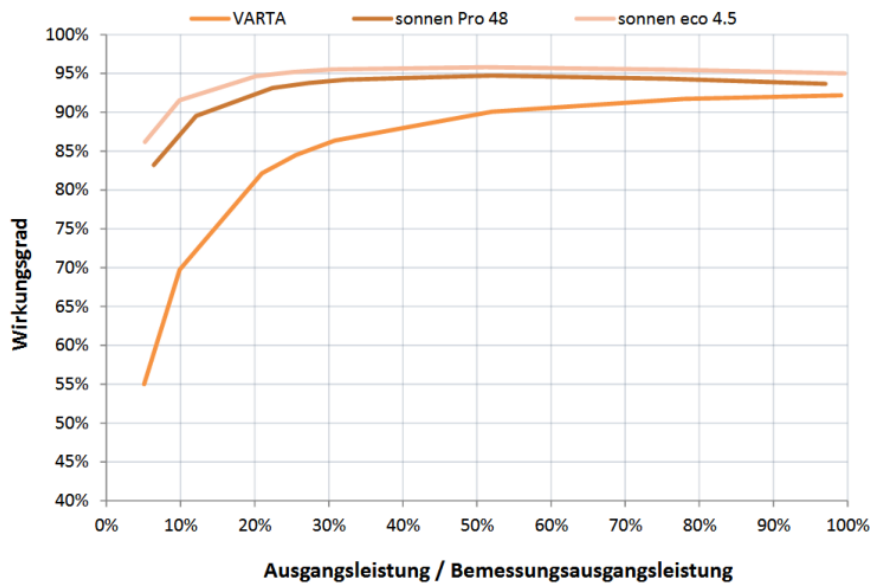

Figure 19: Efficiency of the Varta element 6, sonnen Pro 48 and sonnen eco 4.5 battery system while discharging.

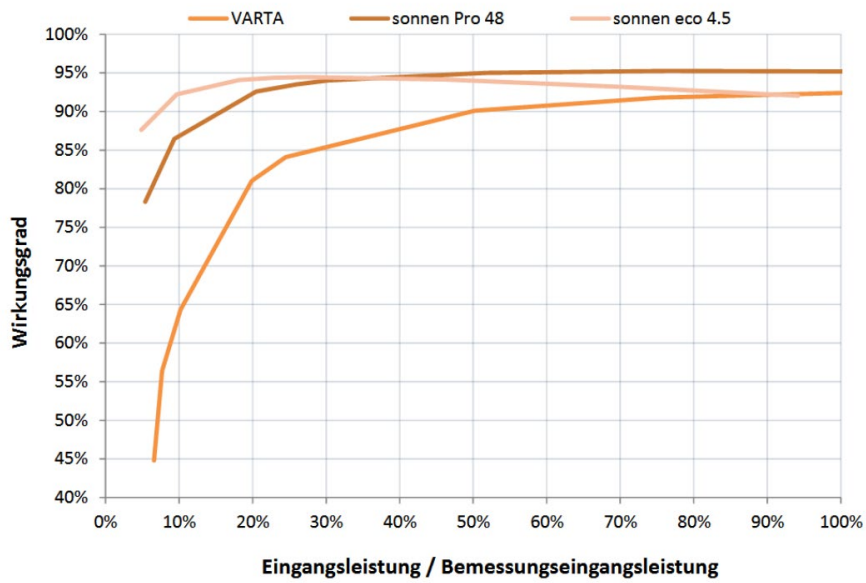

Figure 20: Efficiency of the Varta element 6, sonnen Pro 48 and sonnen eco 4.5 battery system while charging.

Table 23: Standby Losses of the different battery systems.

SOC	Modus	VARTA element 6		sonnen Pro 48		sonnen eco 4.5	
		P <sub>BAT</sub> [W]	P <sub>Netz</sub> [W]	P <sub>BAT</sub> [W]	P <sub>Netz</sub> [W]	P <sub>BAT</sub> [W]	P <sub>Netz</sub> [W]
SOC Max	Idle	0.09	30.38	17.5	47.4	11	5
	Standby-Mode	0.23	11.2				
SOC Min	Idle	0.07	30.56	0.1	37.17	11	5
	Standby-Mode	0.64	11.23				

Table 23 shows that there are big differences in the standby losses of the batteries too. A standby power consumption of 30 W means a yearly energy consumption of more than 250 kWh just for the battery, which can significantly impact the economic benefit of the battery.

The charts and the table show that there are significant differences between the batteries, which show how important the project and the measurements are, because only if such metrics are published, then the manufacturers will work on improving them.

## 9 RQ-3011 Influence of the maximum SOC on battery round trip efficiency

This question aims to answer if the efficiency of batteries can be increased by limiting the maximum SOC.

### 9.1 Summary

The last few percent of charging a battery tend to require more energy and are usually the worst for the life time of the battery. This has been shown in various tests already. And even big car manufacturers such as Tesla recommend only charging the battery up to 80% unless the maximum capacity is needed.

This test aims to quantify the impact of using such a control scheme for PV-Battery systems and the possible efficiency benefits.

### 9.2 Method

For this question measurements were performed using the Varta Element 6. Two measurement series were done. First, for each measurement the battery was fully discharged. Then one measurement cycle consisted of charging up to the desired SOC level and then discharging again to be fully empty. Then the total energy consumption was measured. To account for the influence of standby energy consumption, the waiting time for each cycle was adjusted so that the total experiment duration stayed constant across all experiments.

The second measurement series was the inverse. First the battery was charged to 90%. (90% was chosen since in the test the Varta SOC detection was shown to be rather unreliable as the SOC went above 92%, as is visible in Figure 21.) After that the Battery was discharged to the target level and then charged again. The total energy consumption was again measured and the total measurement time was constant and identical to the first series to make the results comparable.

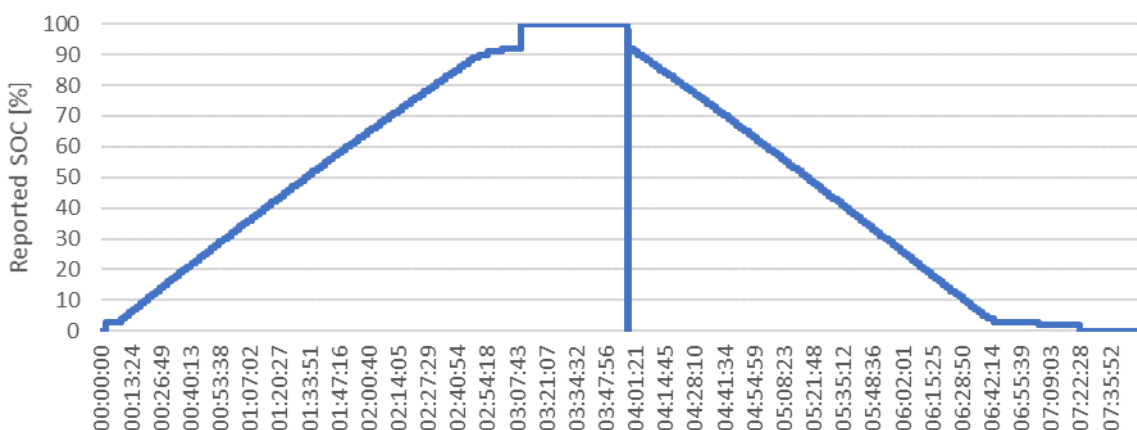

Figure 21: Self-reported SOC of the Varta for One full charge/discharge cycle to 100%. The sudden jump shows that the SOC indicator is having issues above 90%.

For charging the battery the solar inverter was used and set to a constant power consumption. After the battery had reached the desired SOC level, the battery was set to rest for at least 15 minutes before the discharging started.

### 9.3 Results

The results in Figure 22 show that there seems to be some benefit to using this approach. If the battery is used less, then less energy is lost.

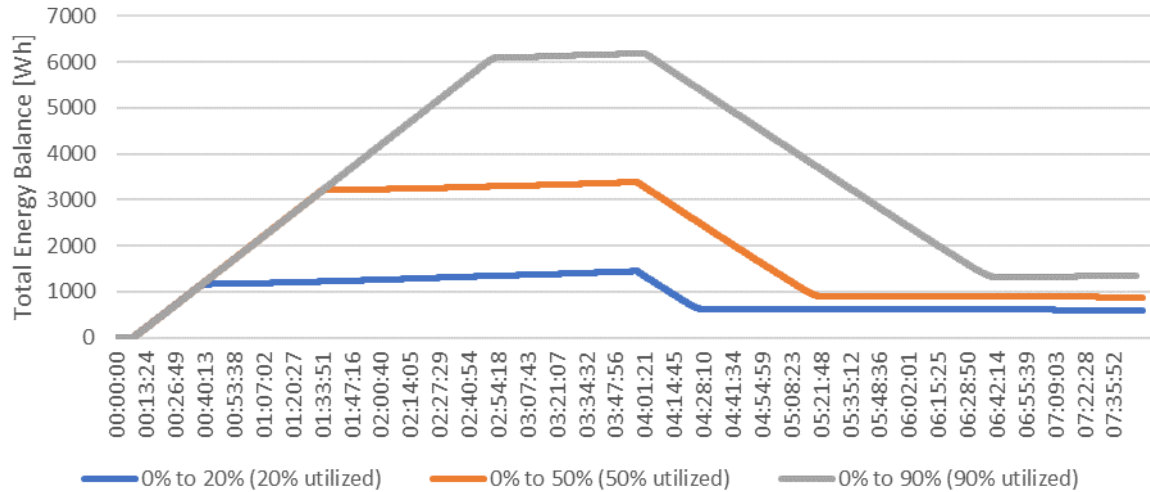

Figure 22: Total energy balance for the first measurement series for charging the battery from 0% SOC to 20%, 50% and 90%. It is visible that the higher the battery utilization, the higher the energy consumption in the battery.

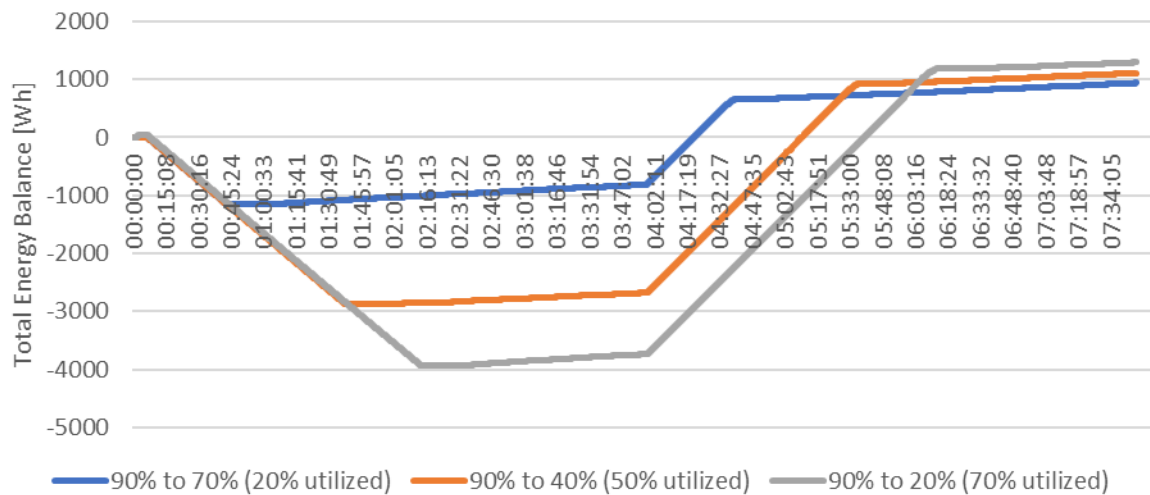

Figure 23: Total energy balance for the second measurement series for discharging the battery from 90% SOC to 20%, 50% and 90%. It is visible compared to the previous figure that the energy consumption at low utilisation of the capacity is much higher than for series 1.

Table 24: Comparison of the energy consumption between the two measurement-series. It is visible that in measurement series 1 (starting from 0%) less energy is used for charging and discharging the same amount of energy from the battery than in measurement series 2 (starting from 90%).

Utilized Capacity	Energy Charged/Discharged [Wh]	Measurement Series 1 Energy Consumption [Wh]	Measurement Series 2 Energy Consumption [Wh]
10%	600	353.7	866.1
20%	1200	593.4	939.0
30%	1800	681.5	991.7
40%	2400	778.7	1'045.8
50%	3000	877.8	1'109.0
60%	3600	995.3	1'191.8
70%	4200	1'127.8	1'290.3
80%	4800	-	-
90%	5400	1'331.1	-

But a more detailed analysis in Figure 24 shows that the energy demand per discharged kWh is falling the more the battery is used. This shows that only charging the battery to 20% and then discharging again means that for every kWh discharged the user needs to put in 1.7 kWh. This means that it is very inefficient to use an oversized battery to cover smaller loads, since the efficiency seems to go up, the more fully the battery is used. This effect seems to strongly outweigh any potential slightly increased losses inside the cells as they reach high levels of SOC. So, in sum, there seems to be an opportunity to save small amounts of energy by operating the battery around an empty SOC instead of a full SOC, but it seems rather more useful to actually size the battery appropriately in the first place.

This finding is relevant for designing a vacation mode for battery systems though: If it is known that the battery will barely be used for a week or two, then it would save energy to empty the battery at the beginning of the vacation to below 50% to reduce losses.

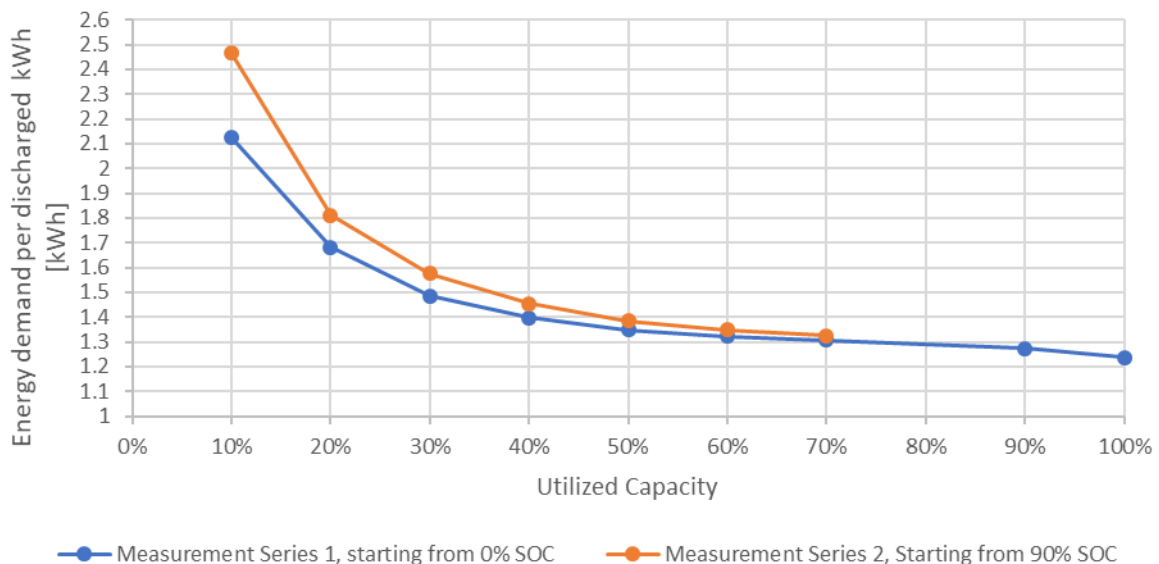

Figure 24: Energy demand per discharged kWh for the two measurement-series. If the utilisation of the battery capacity is low, then it is more efficient to operate around a low SOC. But if the utilisation is close to the entire battery capacity, then the difference becomes rather small.



# 10RQ-3024 Emergency, Stand-Alone Operation of a Fronius Solar Battery System

While appearing as an obvious feature for home battery system, the emergency power use-case poses a challenge for electrical installation and operation as well as for self-consumption optimization.

For many customers, emergency power is a feature that comes automatically with having a home battery system. However, the two modes of operation (self-consumption optimization and emergency power functionality) stand in contrast and, to some degree in contradiction. The self-consumption mode is rather straightforward. The inverter is connected to the grid, and whatever the current solar production and battery charge and discharge is, there is always enough power to operate the connected devices. In emergency power mode, however, battery discharge must exactly match the demand for power, while respecting the power limitations of the battery.

Emergency power mode, including opportunities and limitations, was tested in Prosumer-Lab to assess the implication for customers ordering a battery system and using this functionality.

## 10.1 Method

The following components of the Prosumer-Lab were used:

- PV (DC) emulators with Inverter to emulate the photovoltaics plant.
- Load/Grid emulator for the emulation of the loads. However, in the course of the experiments, real loads (lamps, cookers etc.) were used because the load simulator did not react predictably under test conditions (power-off, power-on)
- Oscilloscope and Net-Analyser Dewetron DEWE-571-PNA

Additionally, setup-specific devices were provided by BKW and connected to the system

- Solar Battery 4.5 kWh (3.6 kWh net), Fronius Symo Hybrid 5.0
- “Enwitec box”: This box has all necessary components such as connections and breakers installed.
- The devices were topologically connected according to the Home Energy standard

Since this research was performed relatively early in the Prosumer-Lab project, the tests were run manually and did not involve the scenario manager.

There was an extensive set of test cases:

- Power Failure and disappearance of mains
- Start of emergency power functionality
- Check of grounding conditions during emergency power operation (safety)
- Check of frequency and voltage during emergency power operation
- Return to normal operation upon mains return
- Timing
- Load test with and without PV power
- Tripping of safety breakers

## 10.2 Results and Discussion

- Once the mains disappear, it takes approximately 50 seconds until the inverter has initiated a local power network
- The local power network has an AC frequency of 53 Hz. This frequency guarantees that other inverters disconnect and do not interfere with emergency power operation.
- The inverter provides the loads with power from both the photovoltaics (if available and producing) and the battery
- The inverter stably supplies the loads as long as the power is within the battery power:
  - Small and medium loads up to several 100 Watt
  - Large loads > 500 Watt
- Phase difference
  - An imbalance of 1650 Watt was tested.

- Change of load
  - The inverter coped with changes in load.
- Tripping of safety breakers
  - Safety breakers tripped in under 200 ms
- TN-S standard must be fulfilled and an additional FI-LS breaker must be installed to ensure personal safety.
- Battery reserve: For emergency power operation, a sufficiently large battery reserve must be defined. The default is 25%, which results in a minimum of 1 kWh of emergency energy available. However, this reserve is not available for self-consumption optimization! So, using emergency power and self-consumption optimization is per definition a trade-off.

## Discussion

The tested emergency power system provides power after an interruption in the mains; however, it does not provide uninterrupted power functionality. The loads are fed by the battery, and if available, by PV power. A local network with an increased frequency of 53 Hz is created. Loads up to the battery power limit can be supplied. Upon return of the mains, the inverter automatically switches over (again with an interruption) to mains again, after some delay.

Emergency power set up must be designed from the beginning: The customer must decide which loads must be supplied in the emergency power case. Large loads such as heat pumps, stoves, oven and other high-power devices cannot be supplied and should not be run during emergency power operation. These larger loads should be categorized with the normal “loads” (which are disconnected, in case of emergency power).

For emergency power operation, additional circuitry and safety equipment and some retrofit is required and may cause substantial increases in the installation cost.

Beyond the scope of system testing, but important for the customer, is the decision if emergency power is required. Since some energy of the battery must be kept in reserve for potential power failures, this amount will not be available for self-consumption optimization. This results in a worse own-consumption and self-sufficiency rate for the plant and therefore increased energy costs. Which aspect is of higher priority is up to the customer and the salesperson to decide.

### 10.3 Summary

The emergency power system using a Fronius Solar Battery in connection with an “Enwitec” Box has the following features and limitations:

- The battery provides emergency power when the mains disappear.
- Loads should be defined either as “normal” or “emergency” loads. In case of emergency power, only emergency loads are powered.
- Only small loads should be emergency-powered (Lights, Computer Equipment, Fridge)
- If power limits or starting currents are exceeded, the inverter shuts down.
- However, the system is not an “UPS” (Uninterrupted Power Supply). There is a gap of several seconds between mains going down and emergency power starting up.
- As soon as emergency power is active, the Inverter provides a stable local network at 53 Hz.
- There is a maximum allowed power difference between the three phases. If the difference is exceeded, the inverter shuts down.
- Additional safety requirements apply (such as special breakers).

# 11 RQ-3026 Solar-Log™ Control of a KEBA-Charging Station and Heat Pump in the Home Energy Environment

How does the Solar-Log™ handle concurrently controllable loads if one of the loads is a KEBA charging station (variable, controllable load) and the other is a heat pump with fixed controllable load?

In single-family homes with photovoltaic production, multiple loads can be controlled to switch on or off, depending on current production. Heat pumps are suitable loads for this kind of own-consumption optimization due to their relatively high-power consumption of 2-5 kW, which is usually on the order of the produced power (around 10 kW). However, many heat pumps run at fixed power, meaning they should only be switched on once production exceeds the heat pump consumption. Alternatively, charging stations for electric vehicles can adapt the charging power and there is therefore the potential to follow the production exactly (within some bounds such as minimum charging power forced by cars). Combining heat pumps and charging stations presents a big potential for overall own-consumption optimization.

In the first part of the study, the charging station was considered individually. The Solar-Log™ provides different modes for controlling the charging station, depending on the customer's requirement. While pure solar charge mode only charges the vehicle with solar energy and thus maximizes self-sufficiency, mixed mode and full charge might be more customer friendly, in that they always ensure that the vehicle is charged.

In the second part, combined operation of charger and heat pump were considered. Controlling both loads to achieve maximum self-consumption is more challenging. In this research question, it was investigated whether and how the Solar-Log™ EMS handles these challenges.

The results of the investigation directly influenced the Home Energy product, as developed by BKW Energie AG.

## 11.1 Method

The following components of the Prosumer-Lab were used:

- PV (DC) Simulators with Inverter to emulate photovoltaics plant. The possibility to control the exact production was of exceptional use.
- Load/Grid simulator for the emulation of the heat pump. Although slightly exaggerated regarding the potential of the device, the load generator allowed to simulate the heat pump consumption.

Additionally, setup-specific devices were brought in by BKW and connected:

- Electric vehicle (Mitsubishi iMieV) connected to the KEBA charging station
- Several ProMod 380 meters, connected according to the Home Energy standard
- The devices were topologically connected according to the Home Energy standard
- Solar-Log™ acquired data from PV inverter, ProMod 380 meters and KEBA charging station and switched on/off the heat pump emulator and/or the charging station

Since this research was performed relatively early in the Prosumer-Lab project, the tests were run manually and did not involve the scenario manager.

## 11.2 Results and Discussion

Part One – Basic charging station control functionality

- Generally, the vehicle cannot be charged, below the minimum charging power (typically 1.5 kW)
- The minimum charging power inside the EMS2 must be set to a value slightly above the minimum charging power of the car (e.g. 1.5 kW vs 1.4 kW). The reason for this is that the car refuses to charge at all if the charging power is below the allowed minimum. In the tests for the mixed mode, this problem arose when initially experimenting with a minimum value of 1.4 kW.

**Pure solar charge** mode only charges the vehicle with available solar power

Advantage

- Self-sufficiency and self-consumption maximized

Disadvantage

- Risk of ending up with an uncharged vehicle if insufficient solar power is available

Final recommendation

- Use for plug-in hybrid vehicles only

**Mixed charge** mode always charges the vehicle at minimum power plus available solar power

Advantages

- Always charge the car when connected with a minimum power
- If more electricity is available from solar production, then this is used as well

Disadvantage

- Minimum power might not be enough to charge the car to the desired level.

Final Recommendation

- Use for balance between own-consumption optimization and charge level requirements

**Full/speed charge**

Advantage

- Quickest mode to charge a car

Disadvantage

- Completely ignores solar production and thus reduces self-sufficiency

Final Recommendation

- Use when car needs to be quickly charged. Note that customer can trigger full/speed charge with a manual switch in standard Home Energy setups.

Part Two – Charging station and heat pump concurrent control

- The Solar-Log™ provides the possibility to control the charging station and a heat pump simultaneously.
- A priority queue has to be defined (either charging station or heat pump as first priority)
- For both devices, a minimum power is defined. For the heat pump, this corresponds to the electric power drawn during operation. For the charging station, this corresponds to the minimum charging power accepted by the car.
- Caveat: Minimum power is reserved for the first device, independently of the actual power drawn by the device. For example, assume the minimum power of heat pump at the priority device is 2 kW, while the minimum power of the charger is 1.5 kW. At 2 kW of solar power production, the heat pump control signal is activated, however the heat pump does not start due to missing heat requirement. The charger will not start until production reaches 3.5 kW (the sum of the devices minimum). This also applies to the opposite order priority. The heat pump is not started until both minima are available, even if the vehicle is not connected at all. Unfortunately, this set-up results in losing a lot of own-consumption potential.

## Discussion

The charging modes provided by the Solar-Log™ in combination with a manual full/speed charge switch satisfies most of the customer requirements. Care needs to be taken regarding the minimum power setting.

When using a fixed power heat pump, together with a charging station, the control algorithms are currently not optimal, own-consumption optimization potential can be lost.

On the other hand, designing an optimal algorithm is not trivial either:

- How is the priority handled? Fixed or dynamic?
- Are there exceptions to the priority setting?
  - for the heat pump, reserve priority in the winter and spring seasons

- charging station yields priority, if car is not connected
- How to act if device does not react to control signal? Give priority to another device? How long to wait until control is given over to another device?
- How to handle the system, if there are more than 2 devices?

Prosumer-Lab allowed us to investigate the basic functionality of the Solar-Log™ for the KEBA charging station, as well as in concurrent operation with a second load, a heat pump.

### 11.3 Summary

The Solar-Log™ in combination with a KEBA charging station supports three modes of operation:

- Pure solar charge (only charge with solar power, green curve)
- Mixed charge (always charge with minimum power plus surplus from the sun, blue curve)
- Speed/full charge (always charge at maximum power, red curve)

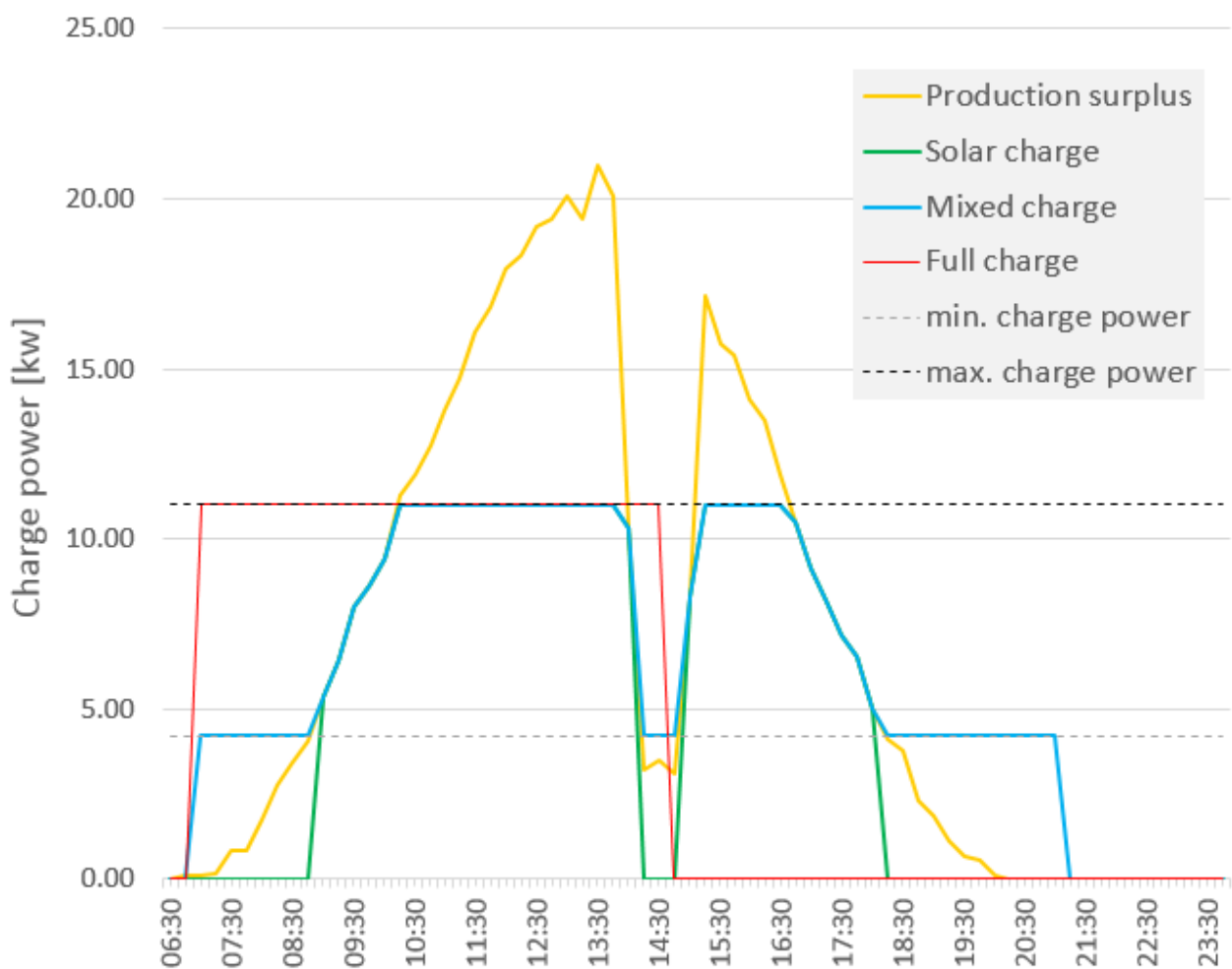

Figure 25: Charging modes in Comparison. Household consumption omitted for clearness. See List above for explanation.

Pure solar and mixed mode optimize self-consumption, while full charge is the default mode if not using an EMS such as the Solar-Log™.

In this part of the research, Prosumer-Lab was exceptionally helpful when being confronted with a problem regarding the minimum amount of power for charging. Fine-tuning of this setting proved to be the solution to a problem where the car charging did not start at all. Without the resources of the Prosumer-Lab, this could have resulted in repeated and cumbersome debug hours in testing or on customer sites.

Regarding the combination of a charging station and a heat pump, it was found that the Solar-Log™ can handle the controlling, with some limitations and caveats. One device has to be given priority with respect to activation, and there is no user-friendly functionality to easily switch the priority from one device to the other. Depending on the choice, the device with lower priority is not started at all or only much later, therefore reducing the potential for own-consumption optimization.

## 12RQ-3033 Validation of the simulation model for PV-Battery systems

As part of the efforts to make battery systems comparable, a simulation model was created by the HTW Berlin. This needed to be validated. The PVLab used the Prosumer-Lab to perform some of the validation measurements.

### 12.1 Summary

To fully test a PV-Battery system under typical load conditions, the performance during an entire year needs to be evaluated. Since running year-long lab tests is not feasible, a model was created by the HTW Berlin that needs about 20 measured parameters. The model is then used to perform simulations for a full year with a time resolution of 1 second and the results are then evaluated, and a system performance index is calculated.

This model needs to be validated. For this multiple universities performed identical measurements on different battery systems and compared the results to the output of the simulation program. In the Prosumer-Lab the Varta element 6 Battery was tested.

### 12.2 Method

For performing this test, the HTW provides load profiles and photovoltaic profiles for 7 days with a 1 second resolution. This is especially important because some battery systems react very slow to load changes and have a delay of up to 30 seconds. This response time is captured in the parameters for the simulation, but to quantify the effects on the battery performance, the simulation needs to have a very fine time resolution. Figure 26 shows the used load profile which is based on measured data. It is visible that the profile contains very high peak loads of more than 8000 W, which help to identify the limits of the battery system.

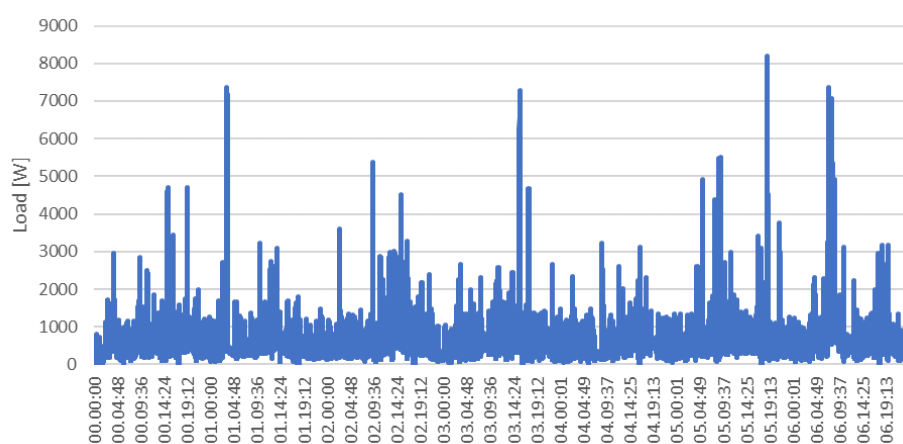

Figure 26: Seven-day load profile for the test.

Figure 27 shows the PV profile used in the test. It is visible that it contains different types of days, both with very predictable power and very fluctuating power.



Figure 27: PV-Profile for the test.

### 12.3 Results

The results are shown in Figure 28. Additionally, the cumulative energy sums are in Table 25. It is visible that the results are very similar, but that the Prosumer-Lab has issues correctly recreating very sharp gradients of multiple kW in a single second. This leads to occasional spikes in the difference view as visible in Figure 29: Difference of simulation and measurement at each timestep Figure 29.

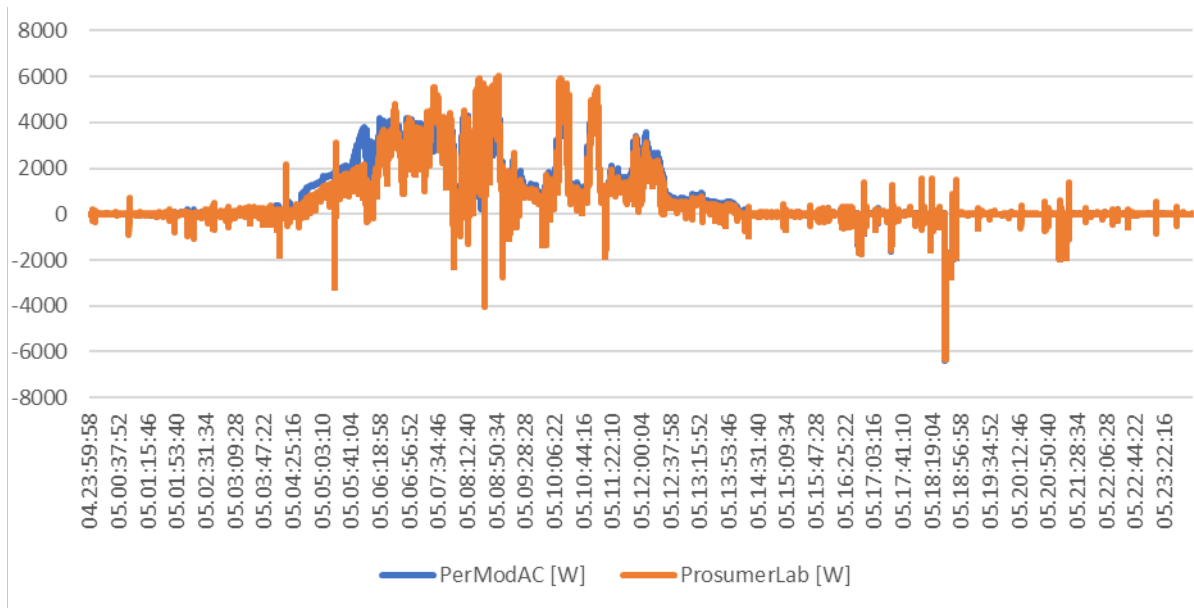

Figure 28: Comparison of the simulation results with the measurement results.

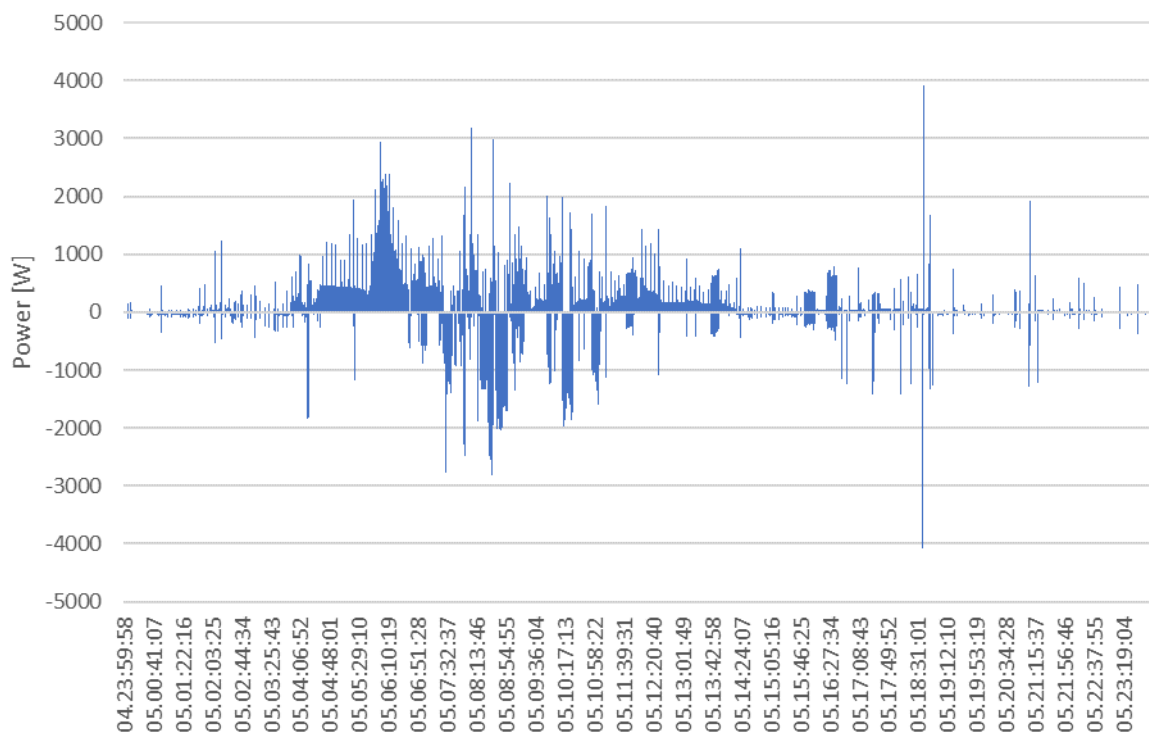

Figure 29: Difference of simulation and measurement at each timestep.

Table 25: Comparison of the cumulative energy sums of the simulation with the measurements.

	<b>Solar [kWh]</b>	<b>Load [kWh]</b>	<b>Battery Charged Energy [kWh]</b>	<b>Battery Discharged Energy [kWh]</b>	<b>Grid Feed-in [kWh]</b>	<b>Grid Demand [kWh]</b>
Measurement	217.4	84.2	39.9	29.8	132.4	10.5
Simulation	219.8	84.5	46.4	32.7	129.4	8.2
Difference	1.08%	0.28%	16.22%	9.60%	-2.26%	22.24%

All in all, the results show that the simulation yielded good results and that the Prosumer-Lab is able to run this kind of validation measurements. But it also shows that the model still has room for improvement with up to 16% difference between model and reality.

## 13RQ-3037 EMS with battery

*What is the incremental benefit by adding a battery in addition to the EMS?*

This research question addresses the issue of how does adding batteries on top of EMS increase self-consumption, degree-of-autarky and OPEX ([linked to electricity buying and selling only, no CAPEX](#)).

### 13.1 Method

In order to evaluate this question in simulation, the same environment as in Section 3 was employed. A battery of 10kWh was added (this is slightly more than the size that would have been obtained using the 1:1<sup>15</sup> rule). The battery was driven by the default Polysun controller that aims at minimizing grid

<sup>15</sup> 1kWh of battery capacity for 1MWh of yearly electric consumption



exchanges (i.e. favour self-consumption. In addition, for S3, several battery sizes were tested in order to see the impact on the SCR.

The same question is evaluated experimentally using the Prosumer-Lab emulation platform. Each EMS was evaluated with and without the Varta battery over a set of 4 different reference days (with distinctive characteristics in terms of load consumption and PV production). The assessment done here is focused on the increase of self-consumption only.

### 13.2 Results

The simulation results, compared to the reference case and EMS1, in terms of SCR (Table 26), autarky (Table 27) and OPEX (Figure 30 and Table 35 to Table 37, in the Appendix) are provided.

In addition, for different battery sizes, simulation results for SCR (Figure 31, Figure 33 in the appendix shows the same result but with a linear x-axis) and OPEX (Figure 32, Figure 34 in the appendix shows the same result but with a linear x-axis), on S3 only.

Table 26 : SCR obtained with the battery compared to EMS1 and reference controller.

	SCR (%)		
	ref	EMS1	Battery
<b>S1</b>	22%	26%	56%
<b>S2</b>	22%	26%	55%
<b>S3</b>	22%	25%	52%
<b>S4</b>	21%	25%	51%
<b>S5</b>	21%	22%	41%
<b>S6</b>	18%	20%	38%

Table 27: autarky obtained with the battery compared to EMS1 and reference controller.

	Autarky (%)		
	ref	EMS1	Battery
<b>S1</b>	26%	30%	65%
<b>S2</b>	25%	30%	64%
<b>S3</b>	25%	28%	60%
<b>S4</b>	23%	28%	58%
<b>S5</b>	24%	26%	49%
<b>S6</b>	23%	25%	47%

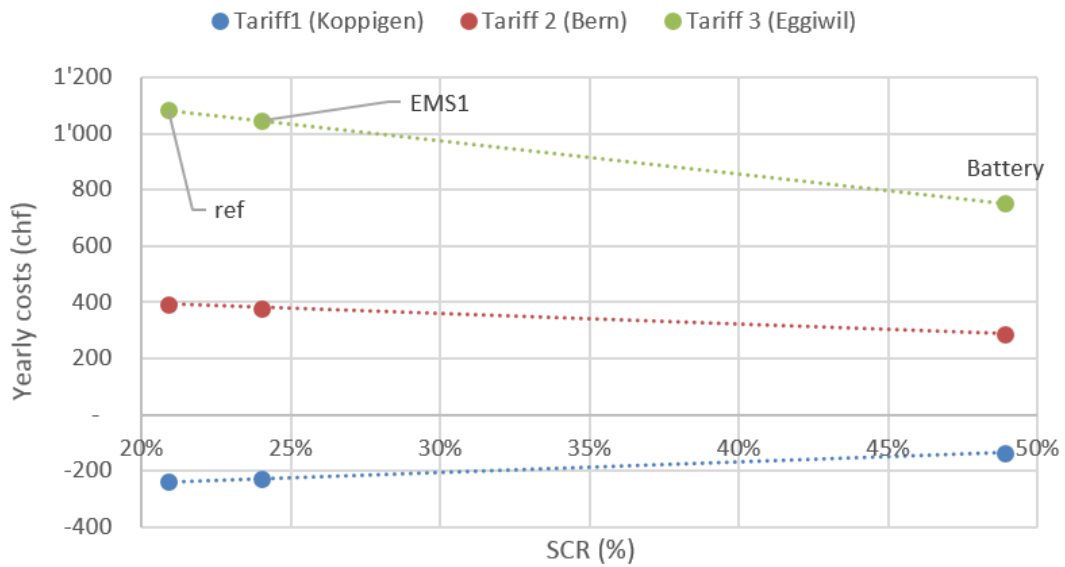

Figure 30 : total yearly cost for the battery, EMS1 and reference controller for the three tariffs

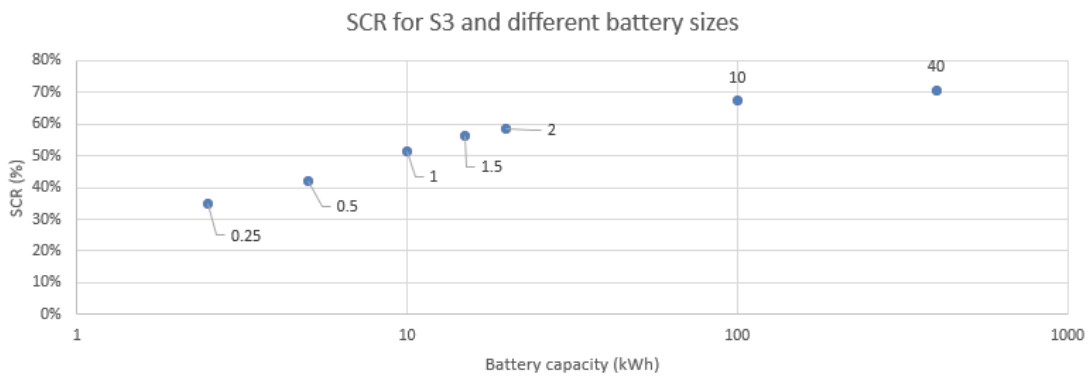

Figure 31 : SCR for the case S3 and different battery sizes (logarithmic scale, the labels indicate the ratio of the installed battery capacity and the nominal capacity derived from the 1:1 rule)

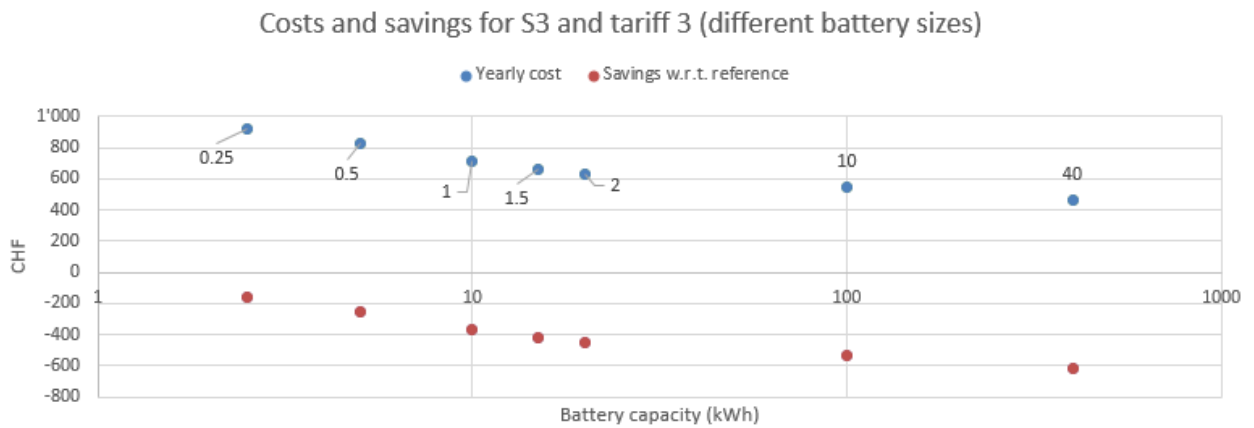

Figure 32 : for S3 and tariff 3, yearly costs and savings w.r.t. reference EMS for different battery sizes (logarithmic scale, the labels indicate the ratio of the installed battery capacity and the nominal capacity derived from the 1:1 rule)

Regarding the results experimentally observed, they are presented in the three following tables. The self-consumed energy (SCE) [kWh] and the self-consumption ratio (SCR) [%] are presented for each EMS and each reference days. Table 28 includes the results without battery, Table 29 with the Varta battery and Table 30 is difference between the results obtained with the battery and without.

Table 28 : SCE [kWh] and SCR [%] achieve by each EMS without battery for the 4 reference days

	Day 1 SCE (SCR)	Day 2 SCE (SCR)	Day 3 SCE (SCR)	Day 4 SCE (SCR)
EMS1	5.2kWh (76.4%)	14.6kWh (43.6%)	10.9kWh (23.2%)	10.6kWh (54.9%)
EMS2	5.4kWh (79.7%)	14.6kWh (43.6%)	11.0kWh (23.4%)	10.4kWh (53.7%)
EMS3	4.7kWh (68.5%)	14.6kWh (43.5%)	11.8kWh (25.1%)	10.4kWh (54.0%)

Table 29 : SCE [kWh] and SCR [%] achieve by each EMS with the Varta battery for the 4 reference days

	Day 1 SCE (SCR)	Day 2 SCE (SCR)	Day 3 SCE (SCR)	Day 4 SCE (SCR)
EMS1	6.6kWh (97.5%)	23.0kWh (68.8%)	19.0kWh (40.7%)	18.2kWh (94.4%)
EMS2	6.7kWh (98.1%)	23.1kWh (68.9%)	18.3kWh (39.1%)	18.0kWh (93.1%)
EMS3	6.7kWh (97.3%)	24.8kWh (73.3%)	21.0kWh (44.9%)	17.9kWh (92.9%)

Table 30 :  $\Delta$ SCE [kWh] and  $\Delta$ SCR [%] (absolute value) achieve by adding the Varta battery on top of each EMS for the 4 reference days

	Day 1 $\Delta$ SCE ( $\Delta$ SCR)	Day 2 $\Delta$ SCE ( $\Delta$ SCR)	Day 3 $\Delta$ SCE ( $\Delta$ SCR)	Day 4 $\Delta$ SCE ( $\Delta$ SCR)
EMS1	+1.4kWh (+29.6%)	+8.4kWh (+25.2%)	+8.1kWh (+17.5%)	+7.6kWh (+39.5%)
EMS2	+1.3kWh (+21.1%)	+8.5kWh (+25.3%)	+7.3kWh (+15.7%)	+7.6kWh (+39.5%)
EMS3	+2.0kWh (+29.6%)	+10.2kWh (+30.4%)	+9.2kWh (+19.8%)	+7.5kWh (+38.9%)

### 13.3 Summary

In simulation the following observations can be made.

First, SCR (Table 26) and autarky (Table 27) are more than doubled by adding a battery. The effect is more marked on the cases S1 to S4 (high to medium insulated buildings) with an average SCR of 56%. The cases S5 and S6 have a SCR of 41% on average, which is twice more as what was obtained using the reference EMS.

Second, OPEX (Figure 30) is logically impacted by the tariffs of Table 19. For grid parity using a battery is undesirable (Tariff 1, Table 19). Whereas for low feed in tariffs substantial savings can be made (Tariff 3, Table 19).

Third, SCR is highly dependent on the battery size for battery values up to 20kWh (the nominal being 10kWh). The SCR plateaus at ~70%, for a battery size of about 100kWh (Figure 31).

Fourth, OPEX is also dependent on the battery size, as illustrated in Figure 32. As for the SCR a plateau is reached at ~10x the nominal battery size

Fifth, when considering adding a battery, by assuming the most favourable scenario coupled to the most favourable tariff, additional yearly savings of ~366 CHF (S1, in Table 37) can be obtained by using a battery of 10kWh. Assuming a cost of 1000 CHF / kWh of battery and a live time of 10 years (this corresponds to ~2000 cycles with the given simulation parameters). This leads savings of 3660 CHF for an investment of 10'000 CHF, resulting in a loss of 6340 CHF. Meaning that installing a battery is currently not desirable, from an economical point of view.

Experimentally the following observations can be made.

First, in general, there is no major difference of performance from one EMS to the next. This observation is expected since the EMS are configured to have behaviours as similar as possible.

Second, the performances achieved by the EMS in terms of SCE by a factor of almost three depend on the day of interest. Indeed, its performance depends on the daily PV production as well as the HP consumption.

Third, Table 30 shows that the addition of the battery allows a gain of SCE from 1.3kWh to 10.2kWh (6.6kWh in average). This gain is once again highly dependent from the evaluated day. Indeed, the performance of the battery in terms of increase of SCE is lower for day 1 since it corresponds to a day with low PV production. That day, a SCR of almost 100% has been achieved (Table 29), meaning that almost the total production has been consumed locally. However, when more production is available, the performance achieved are more interesting.

## 14RQ-3038 Battery control in EMS

*What is the benefit of integrating the battery control directly in the EMS in order to take advantage of a global optimization, e.g. also incl. model predictive control?*

This research question addresses the performance evaluation of CSEM-EMS and comparison to results from RQ-3034 and RQ-3035

### 14.1 Method

It has been outlined that while the control of the battery by a simple EMS will perform well, simple EMS's bring limited benefit to the control of the heat pump. We examine here the additional potential of controlling the heat pump with a global optimization method, in this case Model Predictive Control (MPC). In order to evaluate this potential, scenarios S1 and S5 have been run with an MPC controller. As little improvement was achieved, small modifications in the test case were applied in order to identify conditions where MPC was offering larger advantages.

The MPC controller uses as input the heat demand for hot water production and space heating, as well as prediction of the PV production. It accordingly schedules the heat pump operation to meet the heat demand at lowest possible cost, using the tariff proposed in previous sections.

### 14.2 Results

In scenarios S1 and S5 previously considered, using MPC for the control of the heat pump results in small benefits, similar to the ones achieved by the simple EMS. This suggests that the true potential of optimal control in this case is limited.

The causes for this are the following:

- In the simulation configuration considered, the heat pump needs to start when the controller for the house heating requests heat.
- Small hot water tank with a limited temperature range offer small storage capacity.
- The use of day-night temperature setpoints concentrates all the heat demand in the early hours of the day.

As a consequence, the potential to shift demand over the day is very limited as the house requests heat in the early morning hour and this production cannot be either postponed or stored ahead of time due to the small storage capacity. It is important to be aware that while MPC can find out how to optimally spread heat production over time based on efficiency and cost considerations, it cannot create additional storage capacity.

A variation of case S5 with constant temperature setpoints was then considered. With a constant temperature setpoint, the controller has more opportunity to spread the demand over time. The following table reports the results, comparing a situation with no EMS to a situation with MPC driving the heat pump.

Table 31 : Comparison of performance between a situation without EMS and with a MPC driving HP

Controller	Total cons. [MWh]	Base load cons. [MWh]	HP cons. [MWh]	PV prod. [MWh]	SCR [%]	SCE [MWh]	Cost [CHF]
Reference	11.603	5.000	6.596	12.616	16.06	2.026	1690.00
MPC	11.30	4.99	6.20	12.64	22.90	2.60	1511.00

The MPC controller is able in this case to increase SCR by 7% and cost by 10.6%, benefiting both the increased SCR and the ability to produce heat with higher COPs.

### 14.3 Summary

As MPC needs to work with the constraint of the system (available storage capacity, heat pump average load, etc.), benefits from MPC are inherently dependent on the case considered. While it has been identified that the cases considered earlier offer little opportunity with MPC, we showed that more favourable operation condition can be achieved with small adjustments in the house operation

Further benefits should be achievable if the temperature of the house is allowed to vary in the range rather than be maintained at a precise setpoint. This allows then to utilize the house itself as a heat storage buffer, increasing the shifting potential while producing very limited impact on indoor comfort.

## 15 Conclusion

Given the amount of work covered by this document, the key take home message for each RQ is summarized below:

- RQ-3034 Dynamic EMS interactions: the three tested EMS behave similarly and operate as expected. They yearly energy consumption, varies and can cost up to 12.7CHF.
- RQ-3035 EMS comparison: the three EMS bring similar improvements in terms of SCR (~4%) and operate better on poorly insulated houses. Same applies for autarky.
- RQ-3036 EMS with continuous control: SCR is further improved by 2% and autarky by 1 additional %.
- RQ-3039 EMS sensitivity analysis: PV size increase reduces the SCR (as expected). Tank size increase raises both the autarky and SCR (as for a battery).
- RQ-3040 EMS cost/benefit analysis: savings are highly dependent on tariffs. Even in favourable cases, a long payback time is to be expected (taking only into account the EMS HW cost)
- RQ-3007 Testing of different battery systems for the PV-Battery-System-Standardization: there are significant differences between batteries the considered parameters. Standby consumption can represent up to 250kWh yearly.
- RQ-3011 Influence of the maximum SOC on battery round trip efficiency: the proposed charging strategy (i.e. not maximal) seems to bring benefits. To be further validated.
- RQ-3024 Emergency, Stand-Alone Operation of a Fronius Solar Battery System: the system works as expected. Mostly suited for small loads.
- RQ-3026 Solar-Log™ Control of a KEBA-Charging Station and Heat Pump in the Home Energy Environment: fine-tuning is needed, setting priorities between devices is not user friendly.
- RQ-3033: Validation of the simulation model for PV-Battery systems: the Prosumer-Lab approach is functional. Deviations of ~16% between models and reality are observed.
- RQ-3037 EMS with battery: batteries do improve SCR and OPEX, but installation costs are currently not making this a viable solution
- RQ-3038 Battery control in EMS: using MPC to steer HP or batteries is quickly limited by operational constraints in particular tank size and gains of at most 7% of SCR were shown.

**In summary, it can be stated that EMS do what they are meant to do, however high HW costs coupled to the current electricity tariffs make them not interesting (yet) in addition**

**improvements in user friendliness are desirable. Also, batteries significantly increase SCR and autarky, but their costs are still too high. To some extent, MPC could be improved by using MPC (without having to install costly hardware). Similarly, continuous HP control brings a small additional SCR increase for a low cost.**

## 16 Outlook

HP manufacturers could be interested in implementing the continuous HP control. This implies that the HP can operate in this mode and accept such commands from EMS. With the results of this study, the European Heat Pump Association has been contacted. They were interested in participating in a proposal where one of the topics is to design and standardize a common HP interface useable for optimization in combination with PV and batteries. Furthermore, the Swiss Smart Grid Ready Initiative would be interested in consulting in a project for this part. In addition, contact to heat pump manufacturers has been established to discuss heat pump interfaces and possibilities.

EMS manufacturers could be interested in MPC development. This is a challenging development, as many technical limitations need to be taken into account. In addition, to be effective, access to the heat distribution control (i.e. mixing valve and thermostats) should be available.

## 17List of Figures

Figure 1 : The Prosumer-Lab hardware test environment.	4
Figure 2 : Prosumer-Lab research fields. The ones linked to this report are highlighted in orange. Research fields that provide relevant input are highlighted in blue.	9
Figure 3 : illustration of the EMS switching strategy	10
Figure 4 : Power supply topology and location of power measurement for the three EMS.	13
Figure 5 : Power meter “smart-me Plug” from smart-me AG used for the measurement of the EMS power consumption.	14
Figure 6 : 2-hours load and PV profiles for the dynamic assessment of the EMS.	14
Figure 7 : Daily energy consumption measured for each EMS.	15
Figure 8 : Results of a single dynamic test for each EMS.	16
Figure 9 : Polysun simulation layout for case S1.	18
Figure 10 : SCR as a function of PV size (left), autarky as a function of PV size (right)	22
Figure 11 : electricity consumption as a function of PV size	22
Figure 12 : SCR as a function of tank sizes	23

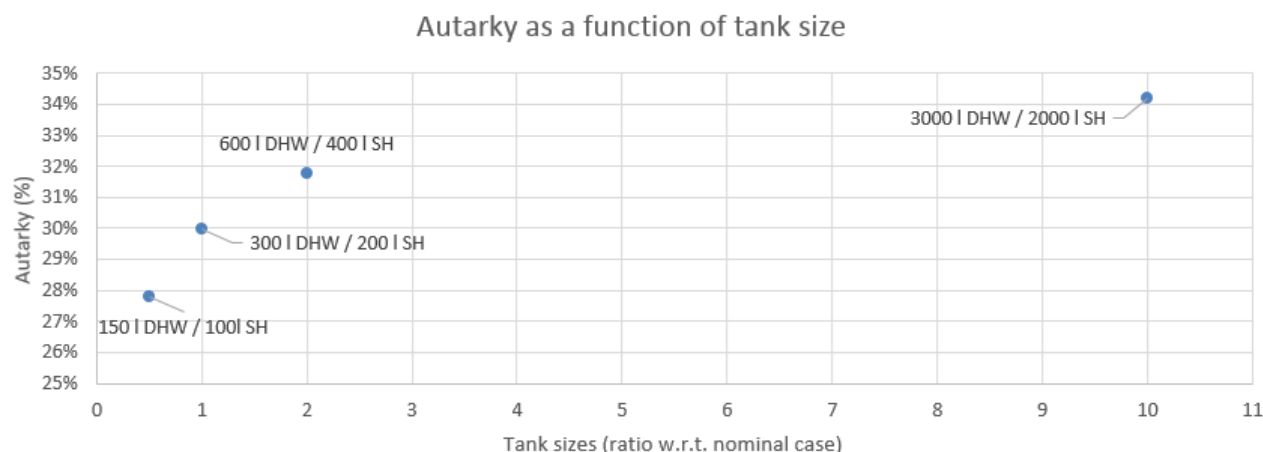

Figure 13 : autarky as a function of tank sizes	23
Figure 14 : total electricity consumption as a function of tank sizes	23
Figure 15 : yearly cost for the three tariffs (including all EMS and) as a function of SCR (smaller costs indicate cheaper solutions, negative values indicate benefits for the prosumer)	25
Figure 16 : yearly electricity cost for S1 using different PV sizes (w.r.t. nominal sizing) (smaller costs indicate cheaper solutions, negative values indicate benefits for the prosumer)	26
Figure 17 : yearly electricity cost for S1 using different tank sizes (w.r.t. nominal sizing) (negative values indicate more gains for the user)	26
Figure 18: Schema of the battery system.	28
Figure 19: Efficiency of the Varta element 6, sonnen Pro 48 and sonnen eco 4.5 battery system while discharging.	29
Figure 20: Efficiency of the Varta element 6, sonnen Pro 48 and sonnen eco 4.5 battery system while charging.	29
Figure 21: Self-reported SOC of the Varta for One full charge/discharge cycle to 100%. The sudden jump shows that the SOC indicator is having issues above 90%.	30
Figure 22: Total energy balance for the first measurement series for charging the battery from 0% SOC to 20%, 50% and 90%. It is visible that the higher the battery utilization, the higher the energy consumption in the battery.	31
Figure 23: Total energy balance for the second measurement series for discharging the battery from 90% SOC to 20%, 50% and 90%. It is visible compared to the previous figure that the energy consumption at low utilisation of the capacity is much higher than for series 1.	31

Figure 24: Energy demand per discharged kWh for the two measurement-series. If the utilisation of the battery capacity is low, then it is more efficient to operate around a low SOC. But if the utilisation is close to the entire battery capacity, then the difference becomes rather small.	32
Figure 25: Charging modes in Comparison. Household consumption omitted for clearness. See List above for explanation.	37
Figure 26: Seven-day load profile for the test.	38
Figure 27: PV-Profile for the test.	39
Figure 28: Comparison of the simulation results with the measurement results.	39
Figure 29: Difference of simulation and measurement at each timestep.	40
Figure 30 : total yearly cost for the battery, EMS1 and reference controller for the three tariffs	42
Figure 31 : SCR for the case S3 and different battery sizes (logarithmic scale, the labels indicate the ratio of the installed battery capacity and the nominal capacity derived from the 1:1 rule)	42
Figure 32 : for S3 and tariff 3, yearly costs and savings w.r.t. reference EMS for different battery sizes (logarithmic scale, the labels indicate the ratio of the installed battery capacity and the nominal capacity derived from the 1:1 rule)	42
Figure 33 : SCR for the case S3 and different battery sizes (linear scale, the labels indicate the ratio of the installed battery capacity and the nominal capacity derived from the 1:1 rule)	54
Figure 34 : for S3 and tariff 3, yearly costs and savings w.r.t. reference EMS for different battery sizes (logarithmic scale, the labels indicate the ratio of the installed battery capacity and the nominal capacity derived from the 1:1 rule)	54

## 18List of Tables

Table 1 : Overview of electrical and thermal characteristics of investigated building configurations.	5
Table 2: Evolution of self-consumption rate as function of battery size, illustration for scenario S3.	6
Table 3 : Self-consumption ratios (SCR) for reference scenario, the three investigated commercial EMS and the theoretical maximum together with SCR for system also including a battery.	6
Table 4 : Overview of the main characteristics of the evaluated Energy Management Systems.	10
Table 5 : Overview of main configuration parameters of the evaluated Energy Management Systems.	10
Table 6 : Varta element 6 characteristics.	11
Table 7: Main features of KEBA KeContact P30 charging station.	12
Table 8 : Overview on thermal and electric characteristics of the reference buildings used in the simulation studies.	13
Table 9 : Main configuration parameters of the evaluated Energy Managers used in the dynamic behaviour assessment.	14
Table 10 : Announced and daily averaged measured power consumption for each EMS as well as the extrapolated yearly energy consumption.	15
Table 11 : Evaluation of the EMS dynamic behavior based on the set of dynamic tests performed.	17
Table 12 : SCR in % for the 3 EMS and absolute SCR increase w.r.t. reference case (in parenthesis).	19
Table 13 : SCE in kWh for the 3 EMS and absolute SCE increase w.r.t. reference case (in parenthesis).	19
Table 14 : autarky in % for the 3 EMS and absolute autarky increase w.r.t. reference case (in parenthesis).	19
Table 15 : SCR in % for the reference, EMS1 and Modulated EMS and absolute SCR increase w.r.t. reference case (in parenthesis).	20
Table 16 : autarky in % for the reference, EMS1 and Modulated EMS and absolute autarky increase w.r.t. reference case (in parenthesis).	21
Table 17 : Tested PV peak powers.	21
Table 18 : Tested tank sizes.	21



Table 19: used electricity tariffs	24
Table 20 : yearly cost difference w.r.t ref controller with tariff 1 (smaller values indicate cheaper solutions, negative values indicate benefits for the prosumer)	25
Table 21 : yearly cost difference w.r.t ref controller with tariff 3 (smaller values indicate cheaper solutions, negative values indicate benefits for the prosumer)	25
Table 22: Tested battery systems.	28
Table 23: Standby Losses of the different battery systems.	29
Table 24: Comparison of the energy consumption between the two measurement-series. It is visible that in measurement series 1 (starting from 0%) less energy is used for charging and discharging the same amount of energy from the battery than in measurement series 2 (starting from 90%).	32
Table 25: Comparison of the cumulative energy sums of the simulation with the measurements.	40
Table 26 : SCR obtained with the battery compared to EMS1 and reference controller.	41
Table 27: autarky obtained with the battery compared to EMS1 and reference controller.	41
Table 28 : SCE [kWh] and SCR [%] achieve by each EMS without battery for the 4 reference days	43
Table 29 : SCE [kWh] and SCR [%] achieve by each EMS with the Varta battery for the 4 reference days	43
Table 30 : $\Delta$ SCE [kWh] and $\Delta$ SCR [%] (absolute value) achieve by adding the Varta battery on top of each EMS for the 4 reference days	43
Table 31 : Comparison of performance between a situation without EMS and with a MPC driving HP	45
Table 32 : yearly cost difference w.r.t ref controller with tariff 2 (smaller values indicate cheaper solutions, negative values indicate benefits for the prosumer)	51
Table 33 : yearly electricity cost difference for S1 w.r.t. nominal sizing using different PV sizes (negative values indicate more gains for the user)	51
Table 34 : yearly electricity cost difference for S1 w.r.t. nominal sizing using different tank sizes (negative values indicate more gains for the user)	51
Table 35 : Yearly cost difference w.r.t. reference EMS for EMS1 and battery for tariff 1.	52
Table 36 : yearly cost difference w.r.t. reference EMS for EMS1 and battery for tariff 2	52
Table 37 : yearly cost difference w.r.t. reference EMS for EMS1 and battery for tariff 3	52
Table 38 : NPV for case S1 after 10 years	53
Table 39 : NPV for case S1 after 25 years	54

## 19Glossary

Abbreviation	Description
BEM	Business Ecosystem Management (BFH-TI)
BFE / SFOE	Bundesamt für Energie
BKW	BKW Energie AG
CAPEX	CAPital EXPenses
CSEM	Centre Suisse d'Electronique et de Microtechnique
EMS	Energy Management System
HP	Heat Pump
LBS	Labor für Batterien und Speichersysteme (Speichergruppe, BHF-TI)
LEN	Labor für Elektrizitätsnetze (Netzgruppe, BFH-TI)
LPV	Labor für Photovoltaiksysteme (PV-Labor, BFH-TI)
NPV	Net present value
OPEX	OPrational EXPenses

PV	Photovoltaic (panels)
RQ	Research questions
SCE	Self-consumed Energy
SCR	Self-Consumption Ratio

## 20 Definitions

### 20.1 SCE (Self Consumed Energy)

Self consumed energy is the energy (kWh) from the PV that is consumed locally (i.e. self consumed)

### 20.2 SCR (Self-consumption Ratio)

SCR is defined as the ratio of self-consumed PV energy (SCE) and total produced PV energy

### 20.3 Autarky

Autarky is defined as the ratio of self-consumed PV energy and total electricity consumption

### 20.4 Reference controller

The reference (HP) controller, is the standard HP controller that aims at maintaining the tank temperatures within the defined limits by using an upper and lower temperature sensor. In addition, it also ensures the right priority between DHW and SH.

## 21 Literature

[1] A. Hutter, et al, "Effizienz von Prosumern steigern", *bulletin.ch*, 8/2019

[2] Prosumer-Lab Test Bench – The smart home in the lab, [www.esrec.swiss](http://www.esrec.swiss).

[3] Polysun Software by Vela Solaris, [www.velasolaris.com](http://www.velasolaris.com)

[4] Load Profile Generator by Noah Pflugradt, [www.loadprofilegenerator.de](http://www.loadprofilegenerator.de)

[5] Nelson Koch, EMS Hardware Emulation - Evaluation Procedures and Results, PROSUMER-LAB document CSEM\_EMS\_HWEvaluationProcedures.pdf

[6] Yves Stauffer, EMS Software Simulation - Evaluation Procedures and Results, PROSUMER-LAB document CSEM\_EMS\_SWEvaluationProcedures.pdf

[7] Y. Stauffer, N. Koch, A. Hutter, N. D. Pflugradt, «Quantifying the potential of smart heat-pump control to increase the self-consumption of photovoltaic electricity in buildings», 12th International conference on solar energy for buildings and industry (EuroSun 2018), Rapperswil, Switzerland, 2018.

## 22Appendix

### 22.1 RQ-3040 EMS cost/benefit analysis

Table 32 : yearly cost difference w.r.t ref controller with tariff 2 (smaller values indicate cheaper solutions, negative values indicate benefits for the prosumer)

	Yearly cost difference w.r.t. ref. with Tariff 2 (Bern) (CHF)			
	EMS3	EMS1	EMS2	Modulated
S1	-17	-13	-15	-24
S2	-18	-20	-15	-30
S3	-17	-10	-18	-31
S4	-14	-18	-12	-28
S5	-15	-6	-14	-31
S6	-16	-18	-17	-34

Table 33 : yearly electricity cost difference for S1 w.r.t. nominal sizing using different PV sizes (negative values indicate more gains for the user)

	PV ratio	Cost difference w.r.t. nominal PV (CHF)		
		0.5	2	5
S1	Tariff1	656	-1'318	-5'273
	Tariff2	494	-913	-3'545
	Tariff3	310	-455	-1'595

Table 34 : yearly electricity cost difference for S1 w.r.t. nominal sizing using different tank sizes (negative values indicate more gains for the user)

	Tank ratio	Cost difference w.r.t. nominal tank (CHF)		
		0.5	2	10
S1	Tariff1	11	28	76
	Tariff2	27	10	50
	Tariff3	44	-10	20

## 22.2 RQ-3037 EMS with battery

Table 35 : Yearly cost difference w.r.t. reference EMS for EMS1 and battery for tariff 1.

	Yearly cost difference w.r.t ref for Tariff 1 (chf)	
	EMS1	Battery
<b>S1</b>	13	110
<b>S2</b>	5	85
<b>S3</b>	11	113
<b>S4</b>	7	89
<b>S5</b>	11	119
<b>S6</b>	5	91

Table 36 : yearly cost difference w.r.t. reference EMS for EMS1 and battery for tariff 2

	Yearly cost difference w.r.t ref for Tariff 2 (CHF)	
	EMS1	Battery
<b>S1</b>	-13	-117
<b>S2</b>	-20	-92
<b>S3</b>	-10	-116
<b>S4</b>	-18	-93
<b>S5</b>	-6	-106
<b>S6</b>	-18	-110

Table 37 : yearly cost difference w.r.t. reference EMS for EMS1 and battery for tariff 3

	Yearly cost difference w.r.t ref for Tariff 3 (CHF)	
	EMS1	Battery
<b>S1</b>	-40	-366
<b>S2</b>	-47	-286
<b>S3</b>	-33	-366
<b>S4</b>	-45	-292
<b>S5</b>	-25	-352
<b>S6</b>	-44	-331

For the Case S1(which has the greatest potential of savings according to Table 37) a net present value (NPV) calculation is done, using the following hypotheses:

- Observation time:
  - 10 years: tested for all tariffs
  - 25 years: for tariff 1 only
- Battery: 10kWh, 10 year life time, 1000 CHF/ kWh installed
- PV: 7.4kW<sub>p</sub>, 25 years life time, 3 CHF / kW<sub>p</sub>
- Interest rate, energy price increase: 0
- Inflation rate: 2%
- PV degradation: 0.5% / year

3 cases were tested:

- No PV
- PV only (with EMS1)
- PV and battery (with EMS1 for HP control and battery controller for the battery)

The results for 10 years, in Table 38, clearly indicate that:

- a) Installing a battery is not desirable regardless the used tariff
- b) Only for tariff 1 installing PV is desirable

When increasing the simulation time to 25 years that corresponds to the life time of the PVs and when comparing the NPV of the case with and without PV (Table 39), it can be seen that minor savings of 2473 CHF can be obtained over 25 years (~100 per year for an investment of 22k CHF).

Table 38 : NPV for case S1 after 10 years

	NPV after 10 years		
	Tariff 1	Tariff 2	Tariff 3
<b>No PV</b>	-10233	-12339	-14505
<b>PV &amp; EMS1</b>	-9869	-14345	-19238
<b>PV, battery and EMS1</b>	-21034	-23820	-26857

Table 39 : NPV for case S1 after 25 years

	NPV after 25 years
	<b>Tariff 1</b>
No PV	-22242
PV & EMS1	-19769
<b>Difference over 25 years</b>	
<b>savings per year</b>	<b>-2473</b>
<b>Savings per year</b>	<b>-98.92</b>

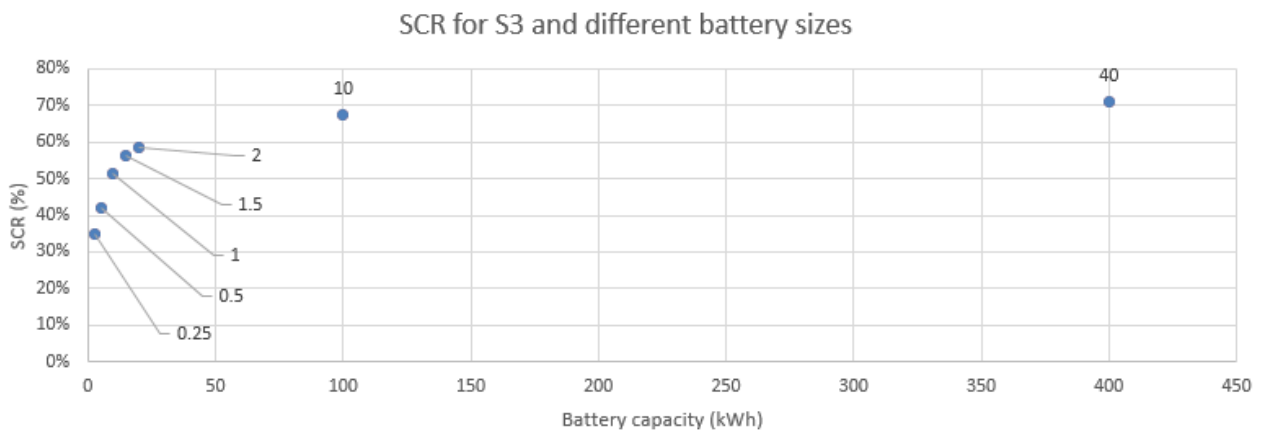

Figure 33 : SCR for the case S3 and different battery sizes (linear scale, the labels indicate the ratio of the installed battery capacity and the nominal capacity derived from the 1:1 rule)

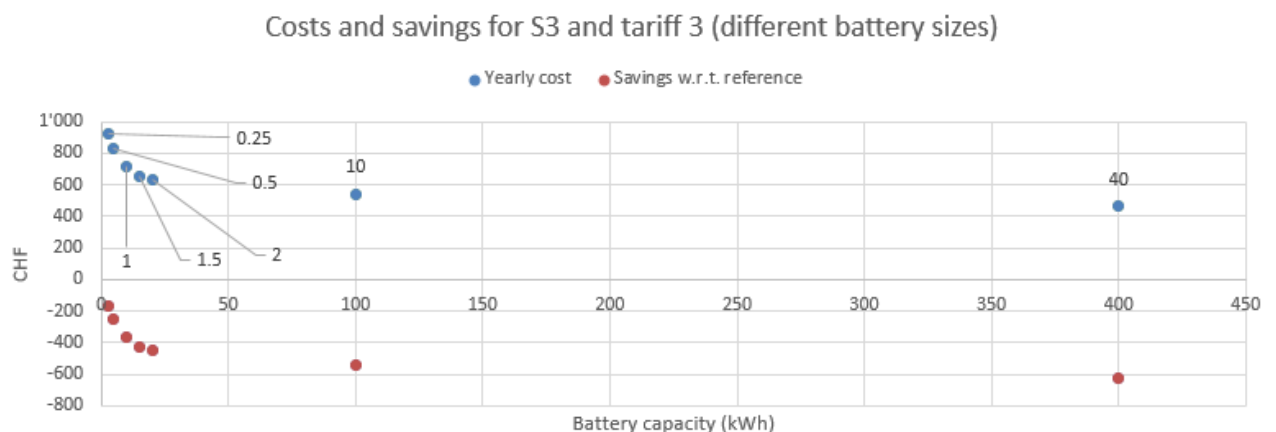

Figure 34 : for S3 and tariff 3, yearly costs and savings w.r.t. reference EMS for different battery sizes (logarithmic scale, the labels indicate the ratio of the installed battery capacity and the nominal capacity derived from the 1:1 rule)

## 23Version control

Version	Date	Description	Author
0.1	25.06.2019	Initial version	Andreas Hutter
0.2	10.07.2019	First version with contribution from CSEM	Yves Stauffer, Nelson Koch, Tomasz Gorecki
0.3	15.07.2019	Merged with BKW and BFH inputs/comments	Yves Stauffer
0.4	04.09.2019	Integrate BFH comments	Andreas Hutter
1.0	04.11.2019	Final version	Yves Stauffer Andreas Hutter